

This work shows the attempt to classify the Hyperfusion method technologically, to differentiate it from existing methods, to show the disadvantages of the prior art and to present the Hyperfusion as a solution.

Inhalt

1. Introduction	2
2. Discussion of the basic strengths and weaknesses of the PBF process.....	5
3. Technical problems with the SLM/EBM processes.....	8
4. Discussion of the basic strengths and weaknesses of the binder process	11
5. Introduction to the Hyperfusion procedure	14
6. The Hyperfusion procedure in detail	19
The principle	30
Discussion of the evaporation energy	32
Matrix creation for metals and plastics: melting or gluing?.....	36
Design	38
7. Outlook	45

Let's start with a basic introduction to 3D printing using an article that I recently wrote for a US magazine, and then work into the PBF, the powder bed fusion process, from the SLS/SLM/EBM HP's Jet Fusion/Metal Jet to explain my latest patent specification.

1. Introduction

3D-Printing: Which way should it go?

A few decades ago, 3d printing was quite easily comprehensible, its three major technologies quickly distinguishable:

1.: Chuck Hull polymerized resin by laser on a top down machine – invented SLA and founded 3D Systems in 1986. Today resin is polymerized by a laser, by a thumbnail-sized chip containing 1-2 million switching mirrors, or by displays like your mobile phone or TV.

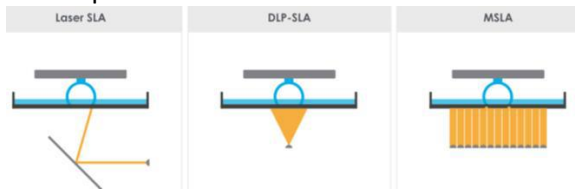

2.: At about the same time Carl Deckard lasered plastic powder - invented SLS and founded DTM, later bought by Chuck Hull's 3D Systems.

Arguably the most promising technology? To be discussed in a later section.

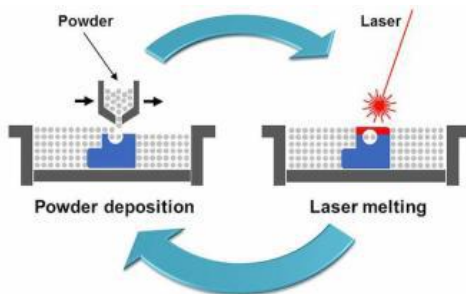

3.: Scott Crump melted a plastic filament extruded by a heated nozzle that laid one beam on top of the other like a Canadian blockhouse – invented FDM and founded Stratasys in 1989; no big evolution can be found here. Today's precision allows for 20 micron layers on good machines. Material diversity grew, like bronze, wood, various plastics, etc.

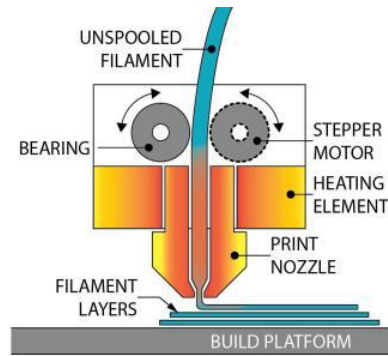

What followed was Polyjetting, where resin is pressed out of a print head like the one in your ink jet printer at home, and binder jetting, where a liquid is jetted onto a powder layer on the print bed so that the neighboring spheres are “glued” together. And barely adopted outsiders like printing and cutting copy-paper, gluing page onto page.

However, even taking into consideration annoying post processing has been conveyed to neighboring machines – now we are talking systems, space for machine parks, and cost - the 3D printing hype came to an end, as reflected by the stock market's 3D printing index PRNT, which is so recent that I have to show you its heavy weight's former chart development in a second graphic in order to let you esteem the gravity of the firestorm that burned previous 3DP-ETFs to ashes:

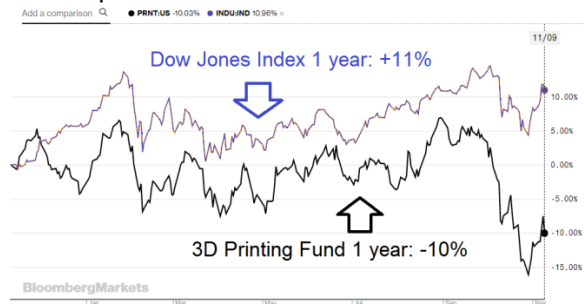

The technologies are quite easy to differentiate by use: FDM = consumer market, the rest is for industry, as the other processes are dangerous (high laser power, carcinogenic resins, nano-

particles in powder, needing mask-protection, evacuation systems, inert gas chambers, etc). However, it is fair to say that even FDM printers ship to industry in order to support show cases by providing prototypes. Remember how hard it was to understand the 2D drawing showing three sides and a lot of cross sections? Now the architect can show the palace to the sheik in 1: 1000 scale – well 1:100 would be sufficient for my house, and it still fits in my palm.



All three major patents expired long ago, yet today we have to learn over 20 new technology-names –mainly because of ego trips and the need to avoid costly patent wars, so every “inventor” slightly modifying a melting (FDM/SLS) or polymerizing (SLA/Jetting) process finds another abbreviation for his/her “paradigm shifting” methodology, enabling him/her to found a company and try to enter the hall of fame.

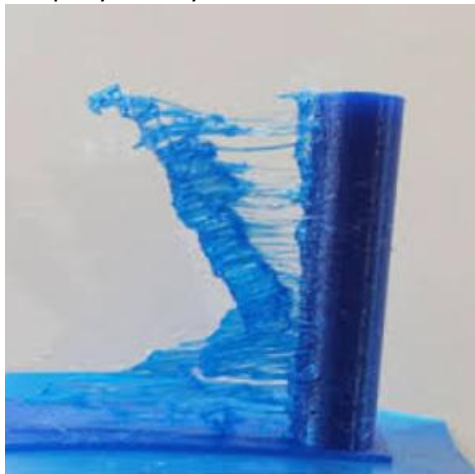

Yet: 3D printing at home gets boring after a while, you cannot make all sizes in full color at a reasonable price, the stuff cracks – if the print succeeds at all....

Worse: The industry is unhappy, having hoped that the transition from prototype to mass

production was just a decade to go; 20 years later it is still waiting. Which printer can replace cheaply ABS-granulate injection-molding machines producing by the millions, especially when the powder is at least ten times the granulates' price? Post processing is another nightmare, besides dim surface finish, part accuracy, strength, porosity, repeatability, etc.

We can quickly exclude FDM from the mass producer's wish list, as the quality, especially in Z, will usually be too poor to ever receive functional parts. The FDM process is well understood and might need color, so we built a 6 filament print head prototype with load control and $2\mu\text{m}$ filament movement detection.

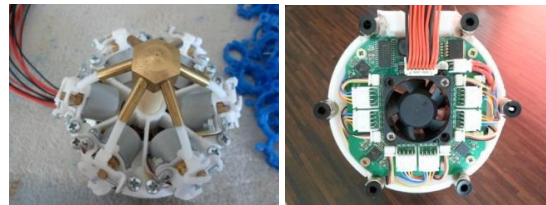

You may have heard of the many breakthrough technology providers like electron-beaming Arcam, Fusion Jetting HP, powder-reusing Aerosint SLS (yes, plastic powder 10-100 times more expensive than the injection molded granulate regularly cannot be reused and has to be wasted!), and we see the advantages of these tech-modifications, but mass production? No way! Arcam's technology serves the military, aeronautical and medical industry, it's for the Formula 1 race car, not for your Toyota. It prints the rocket, not the sprocket, to give you a picture. So instead of bothering you with detailed tech-discussions of “sideways” technologies – those that remain but won't give new hope, possibly leading nowhere - I chose to analyze those methods that have a chance to tempt serving as alternatives, eventually even as replacements, for the mass production systems like injection molding.

Polyjetters using resin are precise, colorful and of better quality than SLA. Here we still have a speed problem, so at geniusprinters, we invented a vertical drum with print heads installed on the inside, jetting outwards.

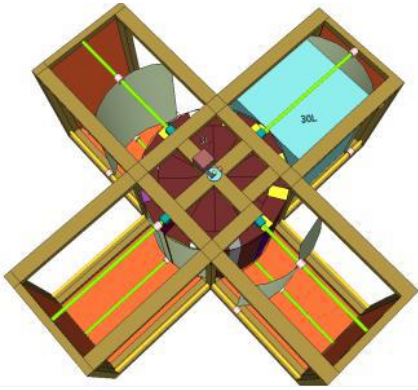

Unidirectional rotations are much faster, and this principle applies to many of our inventions as we will see in further discussions. An automatic 24/7 industrial MJP 4-table printer version is shown here.

All that needs to be discussed is: fusing powder. SLS/SLM/DMLS/EBM/Binder: Metal or plastic? Sintering, melting or gluing? What “adhesion” quality?

You already learned that EBM makes that NASA stuff, an electron beam melts powder on a preheated layer, the part’s surface is rougher compared to SLM machined parts, and the support-points are harder to remove, but the part’s strength is usually better. Hot isostatic pressing helps to come even closer to wrought parts quality. No cheap stuff, but the best we have got so far for “freestyle” designs.

The SLS process in contrast doesn’t melt the powder but just sinters it by staying below the material’s melting point. The part’s strength is worse, internal porosity of 30% cannot match molten part’s strength. Why is that? Well, look at this picture, what is wrong here?

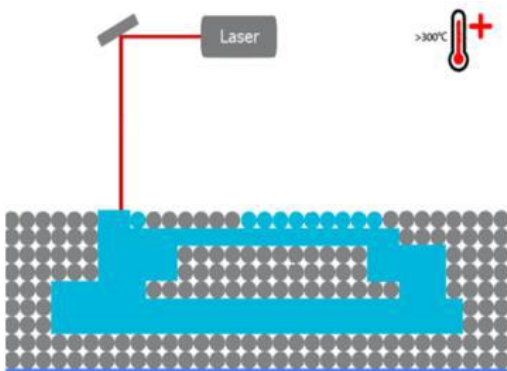

The circle can neither transform into a rectangle of the same layer height, nor could the sphere turn into that cube! Powder printing works best with stacked spheres. $1-\pi/(3 \times \sqrt{2})$ gives you the minimal empty volume, ca. 26%, so 30% is no modest estimate.

In order to revolutionize the 3D printing world by replacing injection molding machines, the task would be to: produce a (drum) printer that is at least 200 times faster than HP’s current Jet Fusion system (another powder sintering process) AND to eliminate the empty-volume-weak-part-problematic AND to overturn the poor surface finish restrictions, AND to work for ceramic, metal and plastics.

That’s exactly what we did at geniusprinters! We are looking for an investor enabling us to exploit our patents, building the world’s first powder-based 3D printer that can print a layer of $1/4\text{m}^2$ within 100 milliseconds. due to its unique drum-printing approach, where, depending on the powder material used, many layers can be glued or even melted at the same time via single pass mode.

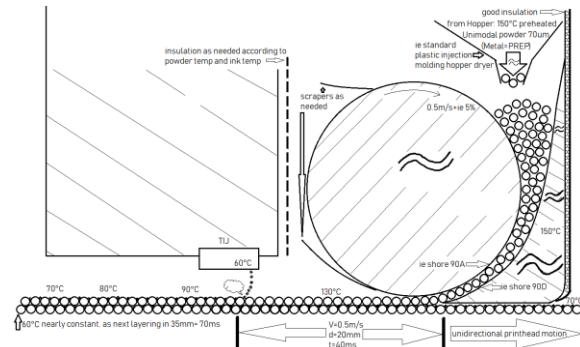

We call this technology **Hyperfusion**. It is faster than HP s and Desktop Metal’s inventions.

Other inventions within our patent portfolio we are keen to bring to market are gel-printing robots allowing for objects of unmatched volumes of $10\text{-}100\text{m}^3$, and house printing robots.

Markus Ulrich is the founder and CEO of geniusthings, the holding of geniusprinters. His think-tank offers unconventional solutions for tough nuts to crack. Markus studied mechanical

engineering, founded and led an IT-database life.
company for 13 years and built machines all his

2. Discussion of the basic strengths and weaknesses of the PBF process

The origin of the 3D printing theory is based on the idea of being able to create products without restrictions compared to conventional processing machines. These have always led to restricted function (e.g. overheating) or complex assembly.

For example, if you wanted to integrate complex heat dissipation channels and functional groups, part-in-part solutions would be required, i.e. an oil flow pipe wound around internal hot zones, a much more complicated function than, for example, undercuts.

The free formability through layer construction leaves nothing to be desired in this regard, the component complexity also increases - if, for example, bearings can be integrated later and no variety of materials is required. After all, the grain can not change its physical properties (although i.e. HP wants to prove the opposite in the plastics sector).

However, the printer is also no cheaper than the injection molding machine, but the materials are much more expensive, and the manufacturing process cannot keep up with the surface optics and haptics, just as little as the physical properties in terms of volume density and tensile strength, yield strength, elongation at break, hardness, fatigue strength, impact strength, ductility, fatigue strength, crack propagation, etc.

Let's look at the following chart:

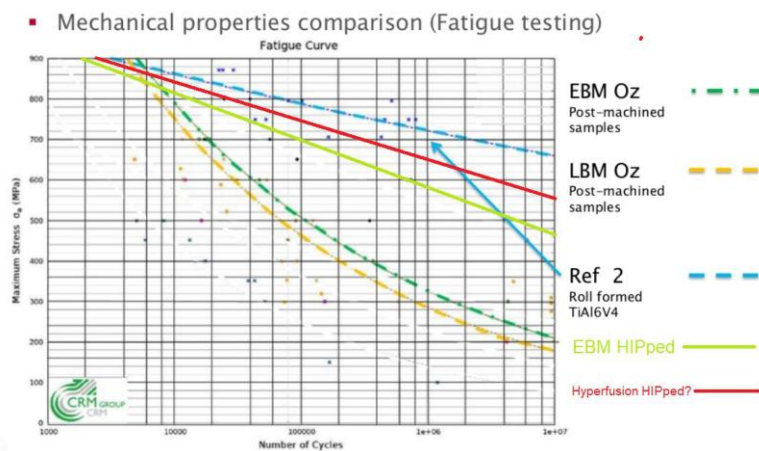

We have to recognize that even an Arcam A2 (EBM = "tube television principle") with HIP post processing does not yet achieve rolled/wrought properties, especially when it comes to the most required repeatability, after all, we want to use it functionally and no one makes more prototypes for the showcase, and not every company can build for one season like Formula One, or like the military only for one shot. Consistency is as important as it is difficult - and rightly pushes 3D printing

out of the hype window, because you are looking for serious alternatives to the subtractive process.

It is therefore a risk to buy new knowledge, material and technology if the restrictions are already known - or worse - they are still unknown!

Tomorrow, the next technology will be exhibited, which can do even more, and the recent investment is now affecting company development, you are no longer at the forefront, amortization is questionable if your own customer prefers to try out the latest toys from the competition. The day before yesterday SLS, yesterday SLM,

today EBM, tomorrow HP Metal Jet and Desktop Metal, then Hyperfusion? The subtractive ways are rolled out, only understandable that the additive business creates confusion.

On the other hand, there is supposedly no waste. But then why is plastic advertised with high reusability of the powder? Because the PBF processes usually heat up the grain and change its properties (MFI), i.e. the grain is brought to just below the melting temperature via glass temperature, whereby the molecules (e.g. PA12) grow and the viscosity increases, which is why the powder flow behavior decreases, the surface roughness increases until the orange peel effect. New powder (sometimes even half of all to be used) must always be added - with a product volume/construction volume ratio of less than 10%, after all, the product should only absorb a small amount of material - so a lot of powder can not be reused. Material efficiency looks different.

Another - very obvious - disadvantage is the size. Even 3.5 million Euros (Concept Laser 2000R) can not help beyond 80x50x40cm = 160L. The Hyperfusion printer with 200L is already a ray of hope. It will be 80-90% cheaper.

Then don't forget the productivity analysis: PBF machines are slow forever! This nine-ton CL2000R colossus builds 120cm³/h, 160L are ready in 55 days, so 10% construction volume requires a good working week. And then the machine has to stop and cool down. Arcam's A2 forces 8 hours of unproductivity here, which of course has to be added to the printing time! During this period, a Binder machine can carry out a complete sintering, we'll get to that later...

So on the one hand, we can be happy that the machine also runs at night, but that's exactly what it has to do because of its snail pace to show any benefit.

As a selling point, it is often mentioned that the machine does not require any tools. I do not share this opinion: tools are a wear agent for product manufacture in the subtractive business. Wear must be checked and costs money. SLM/EBM systems often require more electricity. The pumps, filters and gas cartridges wear out, must be checked and replaced, machines like an Arcam may no longer be serviceable by the user, and maintenance contracts are very expensive.

PBF machines are therefore subject to wear and tear during printing, the costs are not necessarily less than the production costs of a milling center, after all, unused powder (support material), which can no longer be reused, is probably to be regarded as trash.

And let's not compare apples to oranges: tool wear has brought me at least one durable product with the desired surface quality! With the PBF, I have to expect a roughness of possibly 30µm, and who said that the printed products would be true to size without post-processing? Of course they are not.

I do not want to go into DED (Directed Energy Deposition) here because "near net shape" and attention to detail are not yet given, but in my opinion this ten times faster and cheaper method is very suitable as an application to worn tools.

Reproducibility is not certain, since extremely temperature-dependent processes (different laser power due to system aging and machine setting, preheating, absorption of the material, system heat dissipation, material morphology, possibly even different material composition per batch, exposure strategy such as x, y, xy or EOS chess board). In the powder bed process, for example, we are dealing with 1m³ with approx. 1.3m³/(50µm ball diameter =) 65450µm³, i.e. approx. 20 trillion balls, if we want to assume that a 100% volume density will be achieved, 95% is more likely to be the rule.

This also results in an enormous quality assurance effort if differently stored objects of different designs with different wall thicknesses and materials on different machines, possibly even from different manufacturers, should meet the same quality criteria.

This is how we know it from subtractive technologies: everything is standardized, the result is much easier to check. The harmonization of technical rules lags behind the rapid development of 3D printing, in particular quality assurance has yet to convince potential customers.

SLM is also often limited to the use of alloys that require low energy to melt the material. But as always, you try: if you can't do it with a little, you can it with more. The lasers are getting stronger, the deflection units (e.g. from Scanlab) are getting faster, and multiple units are being built into a machine. EBM can also use multi-focus technology (several fields/melting baths are processed simultaneously by jumping the beam back and forth). EOS tries "a million" LEDs.

Due to the inherent stress problems, especially with SLM, where the laser suddenly heats the powder by e.g. 500-1000 °C and allows it to cool quickly to approx. 200 °C, PBF is inferior to the subtractive process. Delay, warping, delamination, balling: we will come back to how difficult it is to find the right (scanning) strategy for every material in order to obtain a presentable, rough, non-dimensional raw material interspersed with support structure points that - if only it could have arisen somehow in the milling center - could have been made there for a fraction of the cost.

You could have processed almost any material there, EBM can only print electrographic, where SLM needs radiation absorbability. Powder dimension diversity might help surface quality and density, but different ball volume needs different melting energy. Diversity is (still) something else. The parameters for each powder only apply to the respective machine of the respective manufacturer.

In the milling center it would have been calculated and profiled according to the directional resilience, at PBF it is not yet known exactly, a lot depends on the scanning strategy, we will look at that later.

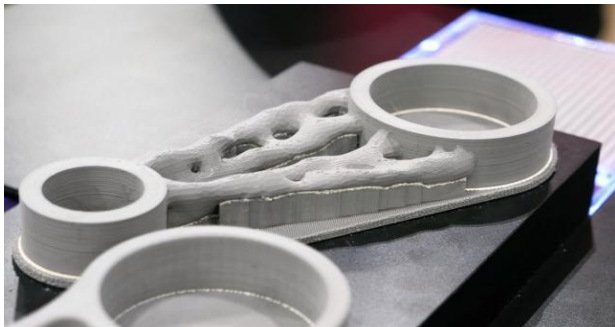

Anisotropy is therefore more difficult to detect, and the designer must first relearn to implement the strength of the 3D printer. The last design step can only be taken over by the software anyway: Complicated calculation procedures convert the "primitive" three-axis structure into generative design, just as nature would have let the product grow. This results in the desired material savings, as the photo above shows.

Conclusion: 3D printing is interesting but expensive, the usual suspects from the big industry are trying out (military/aerospace, but also Formula One and medicine), the mass manufacturers want to get started now, so the times are favorable for HP and similar less dangerous production methods than those mentioned above. Incidentally, HP expects 65% of their binder- printers to be used for prototype construction and only 35% for functional products in 2020, which may be due to the young branch of its recently released metal binder-jetter.



In terms of prototype construction, lightweight construction, functional integration (saving on manufacturing/assembly steps) and customization - especially if it may cost something - the 3D printer is of course unbeatable, print-on-demand companies are springing up, even small series are now feasible, we come back to the mass production usability in Hyperfusion imaging. However, in order to be

able to compare them better, we have to dive deeper into the technical finesse of the known SLM/EBM methods in the next chapter.

3. Technical problems with the SLM/EBM processes

Mastery of the laser melting process (SLM) is made more difficult with non-ferrous and precious metals, which have both a very high reflectivity and a very good thermal conductivity.

Some metals do not absorb more than 30% of the beam power.

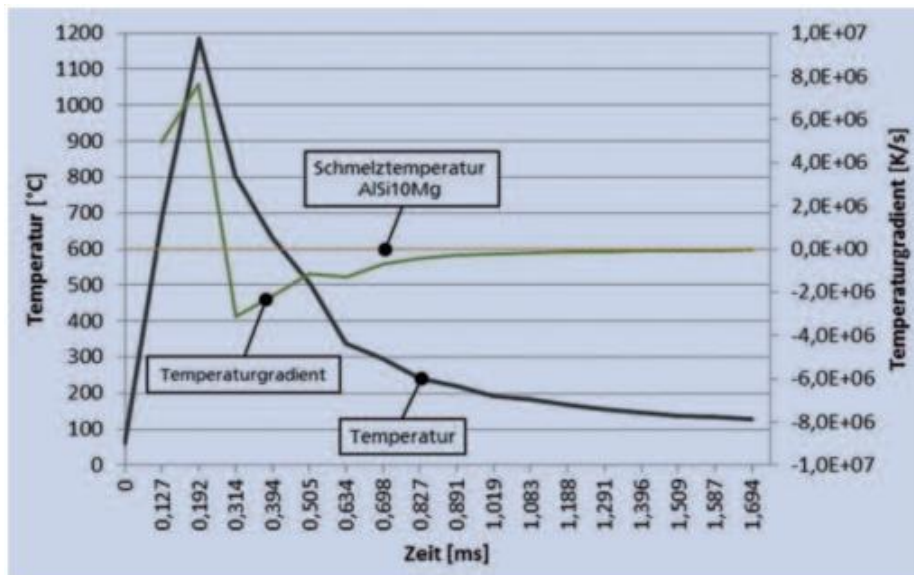

Thermally induced residual stresses arise here due to high temperature changes in too short periods of time, as the graph shows.

In addition, a laser source creates a dangerous beam that the user must be protected from.

A laser is a waste of energy, the power consumption is often ten times higher than the beam power (company SLM: 4kW = 400 laser watts, 10kW for 4x400W).

If the shape of the bead width overlaps the bead previously laid (standard procedure), the structure becomes very anisotropic, see HP's white paper.

The next problem is, of course, the morphology of the material: If the small ball is already sizzled heavily due to its higher surface/volume ratio, the large ball just gets warm. How is a safe merging to be achieved with a chaotic layer?

In the case of plastic in particular, excessive temperatures in relation to the respective material can destroy the molecular structure and completely change the physical properties of the sphere.

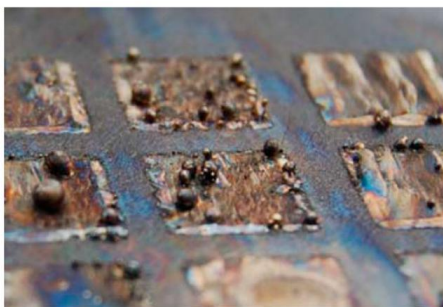

Melt ball formation



Delamination

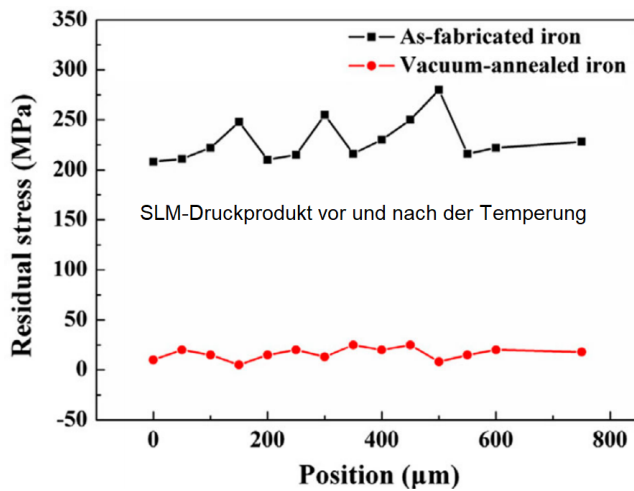

The balling effect is caused by the surface tension, the molten material does not bond enough with the underlying layer. As a result, the weld pool is divided into several individual segments that have poor mechanical properties. To avoid balling, the weld pool must not be longer than twice the width. However, this in turn affects the printing speed, because high-energy-machines can now create the weld beads faster than they cool, and the cooling process in turn influences the development of residual stresses, because after the molten weld beads solidify, local elastic and plastic expansion and compression can occur, and as a result In

addition to residual stresses, there is also distortion, delamination and cracks, as can be seen above. In fairness, however, I must also mention that re-melting with a different scanning strategy can already improve the grain arrangement. In addition, "material emulations" are possible, so scanning processes can change the function. HP claims that this is also possible when binding using so-called "material agents", both for texture as well as for light transmission, strength, ductility, etc. Of course, this only applies to plastic for most properties.

Tempering in post-processing also helps significantly to reduce the residual stresses in the SLM product, as the graphic above shows (although this result is very good).

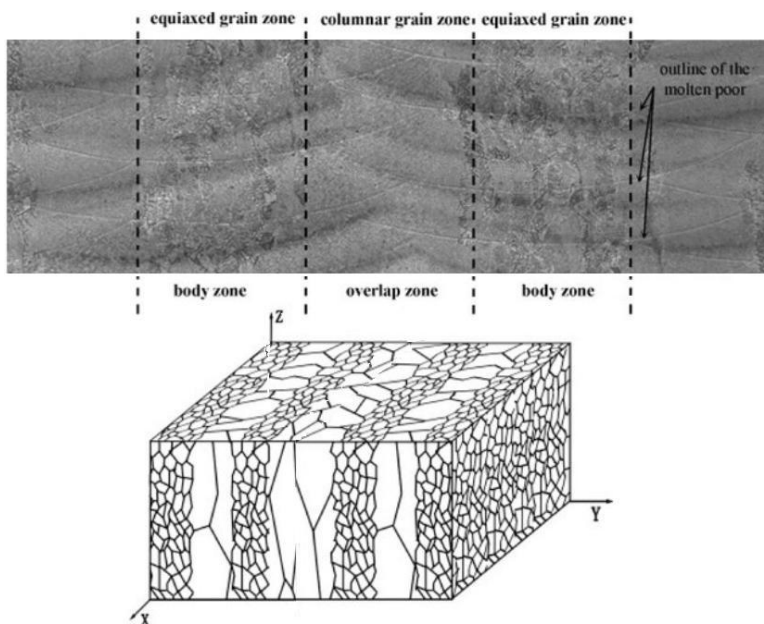

On the other hand, this picture shows that it will be difficult to convert pillar regions into rectified ones:

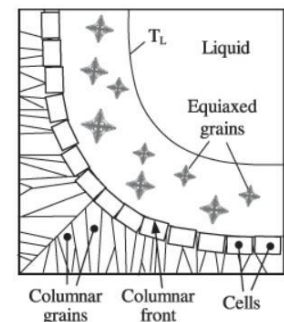

Why do so many columnar grains arise with sinter printing (with SLM even more than with EBM) (see graphic on the right)? Because the material has to suffer large temperature gradients and the product is heated and cooled billions of times, but only once with the binder printing - **gently!**

For other reasons, too, the "what doesn't work with a lot works with even more" strategy doesn't work, as the example chart for Inconel 718 shows:

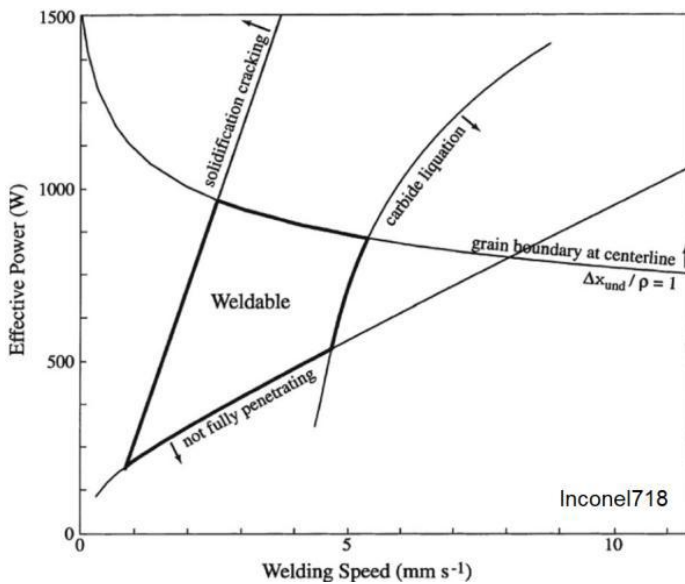

This is a problem with lasers, EBM can/must preheat much higher (because of the increase in

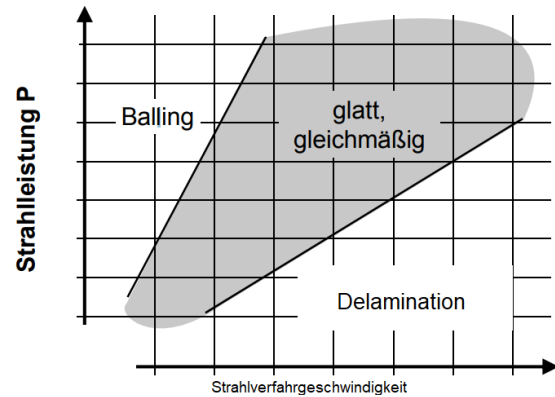

conductivity). The higher the heating (preheating), the slower the cooling process. The scanning

strategy therefore plays an even greater role in SLM than in EBM, which, however, also has more scanning strategy options. Laser-light deflecting mirrors are therefore too slow for complicated scanning strategies, which are very important, but the beam power/beam travel speed ratio is even more important, as the graphic shows.

The Mellon University (et al) shows very nicely below that too much laser power is harmful: the melt pool (red boundary line) is growing, steam is pushing a cavity into the overheated pool. The material (yellow) escapes to the sides and upwards, the surface becomes rough, but above all there will be a point of attack for material breakage.

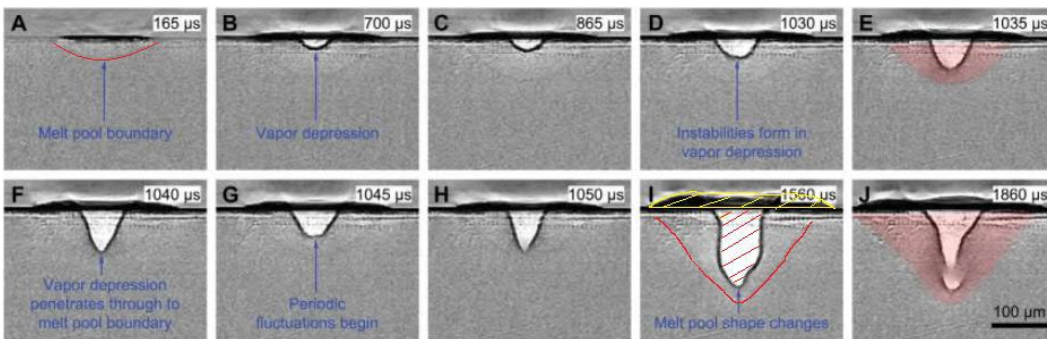

Lasers create ie 1 kW, EBM ie 50 kW, with the same beam focus of approx. 100 μm. With the same current consumption, the beam power of the EBM is superior to that of the laser by magnitudes.

Nevertheless, SLM machines do not print slower than EBM (SLM250/500/Arcam A2): 20/100-170/80cm³/h. In addition, the machines can be used again immediately after printing, the Arcam EBM printer has to cool down for 8 hours, four times as long as SLM machines are unusable. So you have to add this time to the printing time.



An EBM print space must be largely evacuated and provided with an inert gas atmosphere in order to prevent oxidic reactions during processing; SLM does not evacuate necessarily.

In addition, EBM prints less detailed with a rougher surface, e.g. 25μm, vs 10μm for the SLM. Only very limited reactive powdery metallic materials can be used. However, internal pressure-shear stresses are much less present than with SLM products, which therefore often have to

create/print expensive printing plates from the same material in order to avoid warpage. Then the parts must be separated from the pressure plate using a saw, see photo. While lasers position at small angles in the 100 μ s range, EBM do this in the lower single-digit ns range, i.e. at deflection speeds of 10 km/s. EBM distracts faster, the power density is higher. However, only electrically conductive materials can be used. And it creates X-rays!

The electron beam focus, the associated electron beam power and the feed rate determine the time course of the energy input, the cooling behavior determines the expansion of the weld pool.

If too much energy is applied to the EBM, the layer ball can evaporate/spray smoothly due to repulsive forces caused by electrostatic charge, and a nice hole is created. This happens when metals oxidize, neighboring spheres have different compositions, or (most likely) the electron flow is not passed on/off. Therefore, the layer ball conductivity has to be increased in a time-consuming way by creating sintered necks of the balls by scanning the entire layer at approx. 10 m/s for example, in order to heat steel balls to 1000 °C. As a side effect, less support structure is required, the support balls stick together, and surprisingly it could not be confirmed that the physical properties of the support balls are changed in such a way that, as is (still) common in the plastic process, they are not 100% recyclable.

The HIP process can cause changes/movements/mutations in grain size, grain orientation, phase precipitation, porosity and mechanical properties. The thermal after-treatment of metal influences the microstructure development through dissolution, precipitation, recovery, recrystallization and growth. Recrystallization is taken care of in order to promote the formation of a rectified microstructure from a columnar microstructure, since SLM products in particular generally have a columnar-oriented microstructure. The useful parameters for TiAl6V4 were determined empirically: 2 hours at 900 °C with 900 MPa, then 180 \pm 60 min at 895–955 °C at a little over 100 MPa. Inconel 718 can be cheaply HIPed with: 4 hours at 1120 °C with 200 MPa. If you only want to achieve a heterogeneous grain structure, tempering may be sufficient, with IN718 partially recrystallizing already during tempering.

Conclusion:

Both methods (SLM/EBM) have in common: They are dangerous: electrostatic charges, 10kW beam power, 60kV at the cathode, X-rays, or 1000 watt laser on reflective metal, inert gas, ...that sounds expensive: SLM 250/280/500: 0.5mil/0.6mil/1.2mil €; EOS m290: € 0.2million, EOS 396: € 0.35million; Concept Laser 2000R: € 3.5 million.

4. Discussion of the basic strengths and weaknesses of the binder process

Binder technology, developed in 1990 by MIT, Boston, is used commercially by Voxelet, ExOne and Z Corp (3D Systems). In contrast to the SLM/EBM methods analyzed above, the layer is cold-set; the complicated and time-consuming warming up and control of the temperature is eliminated, a big advantage. So it's not the beads that are treated, but the gaps between them. With $1 - \frac{\pi}{3\sqrt{2}}$ the best ball packing density results in an empty volume of 26%, small balls in between can reduce it, but hinder the flow, uneven heights produce uneven surfaces. Special attention is paid to layering in the Hyperfusion process, so we will deal with this topic later, both theoretically and practically.

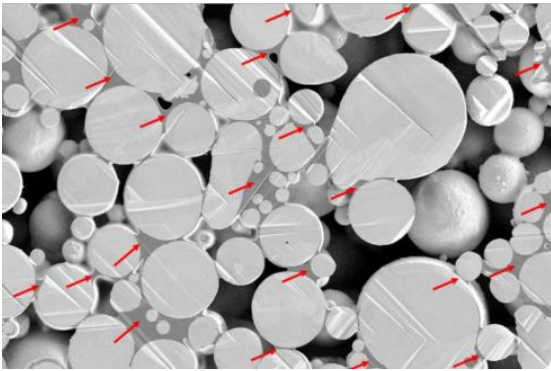

Wikipedia characterizes the binder process as follows: "In theory, all materials can be used as long as they can be glued to the binder. In particular, food or temperature-sensitive substances such as pharmaceuticals can also be processed. It is also possible to use different binders within a single work piece, thus creating areas with different mechanical properties. Numerous substances can be used as a binder, e.g. those based on water, synthetic resin or living cells. In principle, the powders do not have to be identical in every layer. In addition, similar to laser

sintering, binder jetting does not require any support material because the work piece is carried by the powder during the production process. However, 3D printing does not provide a particularly strong work piece. Especially when using metals as materials, the work pieces have to be subsequently freed from the binder and sintered to ensure sufficient strength. This leads to shrinkage, so that the final geometry is difficult to set in advance, but this can generally be mastered with sufficient experience. " Basic manageability can therefore only be understood as near net shape, and I have to come back to the porosity, which was already addressed and described as empty volume: it provides weak cohesion between the sintered spheres and therefore influences the physical properties (stretching but above all tensile forces), because if they occur uncontrollably in the SLM, for example, the heat dissipation was incorrectly calculated, which now leads to swelling of subsequent layers and even can lead to balling.

ExOne (approx. 150 machines sold at approx. \$ 0.5 million) infiltrates metals with bronze and can produce 160L in 44 hours, i.e. 3.6L/h (MFlex at 1min/0.15mm layer thickness) with + -1.3mm accuracy for an 80x50x40cm product (very imprecise) print. This makes the printer extremely fast compared to SLM/EBM (0.1L/h)! However, accuracy may not play a major role ;-). We will analyze the attempt to find a "near net shape" formula later. ExOne uses binders to be sprayed with furan, silicate, phenol for sand printing and water-based ones for metal printing. HP does a very similar thing with the metal jet machine: the binder suspension contains polymers in the water, and the passing wave emitter causes the polymers to harden. These polymers form a lattice structure that binds the metal balls individually (enclosing them is out of the question, as HP's photo shows).

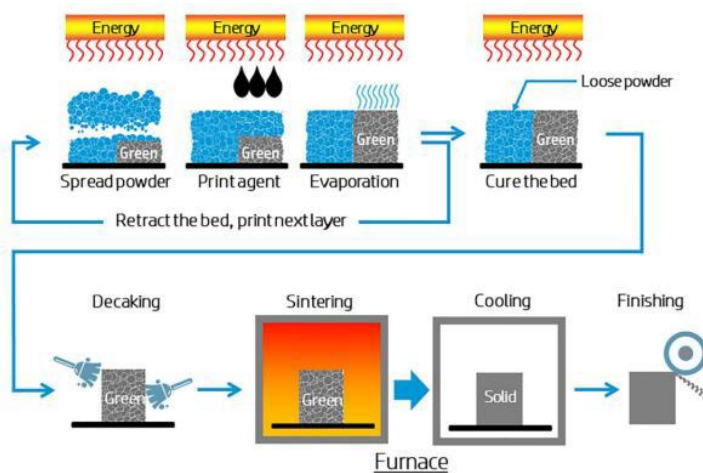

HP's Metal Fusion

Desktop Metal, a unicorn (pre-IPO value > \$ 1 billion) and a newcomer who received five times more investments (over ¼ billion from Ford, GE, BMW and others) before even selling one production-system, so 5x more than the sand/plastic-binding company Voxeljet is still worth on the NYSE-stock exchange, also shows that metal printing is currently a sexy story - also for HP. And since the name already says that Desktop Metal only wants to take care of the most interesting material, they get hype status.

Incidentally, the printing processes for HP and Desktop Metal are very similar and have in common with Hyperfusion and ExOne that a grid structure between the cold-set metal balls is sufficient to push the product into the oven. This ends the

similarities, however, because ExOne does not allow the entire volume of a print-head for some machines and therefore has to move it several times; the first versions of the newcomers mentioned above are not yet that big. HP drives cross-wise - simply taking over the Jet Fusion System - the layering process takes place across the Jet irradiation process, but is at least reduced from a three-step process to a two-step process, whereas the Desktop Metal production-system (I only describe this, the smaller studio system is not relevant here) can work in single pass mode. This is very important for the Hyperfusion theory, because it has already been shown that single mode works. Laying times of $(12\text{L/h} = 3/4\text{m} \times 1/3\text{m} \times 1/4\text{m} = 62.5\text{L}, \text{ i.e. } 5.2\text{h}$ for printing the complete installation space at $50\mu\text{m}$ layer height; $= 5000 \text{ layers}/5.2\text{h} = 3.74\text{sec}/750\text{mm}$) $= 1\text{m}/5\text{sec}$ are reached. So $20\text{cm}/\text{sec}$ are not a problem, HP Metal Jet ($430 \times 320 \times 200\text{mm} = 27.52\text{L}$) does not yet state any printing speeds in the white paper, but the Integra P400 from EOS is already traveling at $40\text{cm}/\text{s}$.

The polymers are completely dissolved in the sintering furnace, as HP writes. HSS processes spray, for example, soot-like particles - such as filled ink, which then simply brings IR surface-irradiated material over the melting point at the sprayed location through absorption; but that means that the balls have to be preheated exactly again. HP's Jet Fusion machine (e.g. for PA12) must also preheat, like HSS and SLM/EBM.

As soon as a part of the PA12 powder has melted, it is drawn between the powder particles due to the capillary forces and a rearrangement of the powder system is triggered. EBM creates steam capillaries due to the high energy density in the jet. HP also mentions capillary forces in the metal jet that are supposed to pull the polymer chains into the cracks between the balls. The definitions got a little mixed up during the rapid developments: PBF, as a powder-bed fusion, is a fusion of the powder that was previously rolled onto the bed. This applies to EBM, SLS, SLM, HSS, Desktop Metal and HP Jet Fusion. A DE (D) in the sense of directed energy is DED as well as EBM, SLS and SLM. Area radiation is available from HSS, Desktop Metal, HP Jet Fusion as well as HP Metal Jet and the Binder process from Voxeljet and ExOne. Different powders can be printed here, as long as flow and sinterability are guaranteed.

Each ball fusion works with temperature gradients; from RT to T_m can only be seen with some binder processes (e.g. ExOne-M and HP Metal Jet, the latter being able to heat the layer for the purpose of binder evaporation = RT) which subsequently sinter = T_m . All other processes require powder preheating, be it from approx. $170\text{ }^\circ\text{C}$ for HSS, HP Jet Fusion, SLS, or approx. $200\text{ }^\circ\text{C}$ for SLM, or just under $800\text{ }^\circ\text{C}$ for EBM, unless they do not melt and jet binders as "adhesive" on e.g. grains of sand, such as Voxeljet-S, ExOne-S and Z Corp (3D Systems). The higher the temperature gradient, the more vulnerable the process is. The reverse also applies to the conclusion:

- 1. the gentler the material is brought to sintering temperature, the better the product, and**
- 2. the less dangerous the process, the cheaper the machine, and**
- 3. the more printing area the mechanism offers, the higher the productivity, and**
- 4. the denser the printed volume, the less shrinkage occurs during sintering, and**
- 5. the fewer properties the printing powder must have (heat-conducting, light-absorbing, current-conducting, iron-containing, etc.), the more materials can be used.**

Everything is quite logical, actually. These are the key points, properties and motives for my Hyperfusion idea. We now come to the discussion of layer sphere geometry and layer morphology.

5. Introduction to the Hyperfusion procedure



It all starts with the spherical shape, size and composition, although the material is not described in this article. The Melt Flow Index (MFI) depends on the powder shape and size homogeneity.

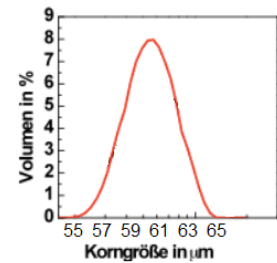

The Plasma Rotary Electrode Process (PREP) seems to be the only one that is most likely to get the best spherical shape. Further filter/sorting processes may have to be tried to limit the size to 55-65µm. Of course, smaller diameters are also acceptable, as long as a steep Gauss-bell ensures the same narrow size distribution, see example graphic.



I do not share the view that small balls increase the packing density, they only do so at the expense of poorer flow behavior and uneven height conditions, which only make the body more porous or produce an even more light-absorbing surface. Here are a few considerations and calculations: With the best ball packing density, we get an empty volume of 26%, as



described above (for spheres of the same size), for example with an hexagonal arrangement. Now each sphere surrounds an octahedral hole and two tetrahedral holes, as the photos show. The latter is much smaller than the former, so we determine its size: It is half the magnitude of the desired layer sphere diameter, which would result in a combination of a sphere with 60µm and a 12µm diameter for each tetrahedral hole, plus approx. 5 balls around an octahedral hole fill. We do not want to and cannot introduce a third diameter here because the chaotic layering cannot lay/stack the balls as desired.

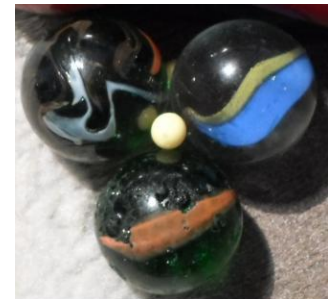

Grain size 60µm = 113000µm³, grain size 12µm = 905µm³, 7 of them per large ball.

Let's fill up a cube of 10cm³: We achieve 74% volume filling when the large balls reach the upper cube level with 65 million balls, the remaining 2.6cm³ should now be achieved with 905µm³ per small ball. We can only hold 7 small balls per 905µm³ per big ball, so we get 7 x 905µm x 65mio = approx. 0.41cm³, that is only 16% of the desired 2.6cm³! 16% is insufficient for the effort and so

we prefer to lay the layer only with a large sphere and to fill the holes 100% instead of 84%. How to do this is discussed later.

In order to improve the pressure, the specialist literature suggests that the empty volume be given an improved volume density by means of cleverly selected dual/multimodal more or less constant diameters. McGeary is said to have already reached 82% with 10:1 powders, i.e. the use of two precisely coordinated diameters of 60 and 6µm, for example. According to my analysis above, I don't get 80% with 5:1 and I strongly advise against using

powder in the single-digit μm range, the production of exactly $6\mu\text{m}$ balls would be a nightmare and dealing with it would be dangerous, especially if we want to think of $25\mu\text{m}$ to $2.5\mu\text{m}$ constellations. Therefore, I reject the use of defined multiple diameters, producing balls between 55 and $65\mu\text{m}$ is feasible with PREP and already expensive enough and initially produces a lot of rejected, re-melted balls of unsuitable diameters.

Now let's take a look at the post process, the end result of which has to be measured against the SLM/EBM products before we come to the characteristic differences between Hyperfusion and Desktop Metal's machine or HP's Metal Jet.

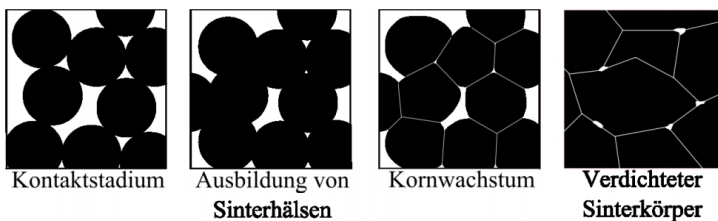

Forming (printer) is separate from grain orientation (furnace). In contrast to the EBM process, for example, which sinters IN718 at approx. $975\text{ }^\circ\text{C}$, we can choose the temperature and its gradient very precisely in the binder-post process and change it comfortably in all given homogeneity. First of all we

Ink Jet gedruckte
Ag-Strukturen

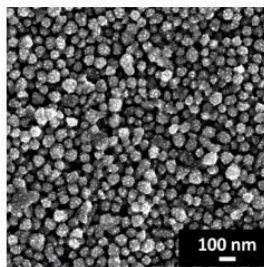

Substrateheizung: $60\text{ }^\circ\text{C}$
 $R = 30\ \Omega$ bis $600\ \Omega$

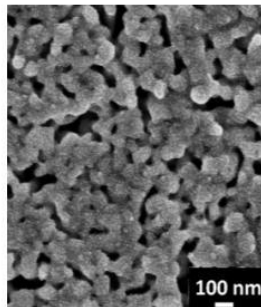

120 Minuten $150\text{ }^\circ\text{C}$

have to take care of the binder material, it usually has to be dissolved so that the layer balls can touch and connect. Binder processes work with sprayable liquids. Here, the viscosity of the medium and its maximum heatability in the cartridge must be observed relative to the piezo force of the print head. Diethylene glycol in water solution (e.g. water-based binder consisting of ethylene glycol monobutyl ether CAS # 111-76-2 and ethylene glycol CAS # 107-21-1, subsequent surface heating at approx. $200\text{ }^\circ\text{C}$ necessary), phenol (without subsequent

surface heating) and other liquids are used as binders in question. If polymerization is desired, surface irradiation must be carried out with a UV bar. Attention must be paid to drying times: Diethylene glycol actually takes time, while phenol is simply sprayed on untreated. Metals conduct heat at different speeds, but at least better than plastics, so that -depending on the binder/layer ball volume ratio- hardening can be achieved more quickly at higher heat-dissipation rates. It is important that all unwanted binder ingredients come out during the "binder burn-out" so that the sintering process is not disrupted by impurities in the print. One first thinks of MODs, i.e. metal-organic decompositions, which - unlike nanoparticle suspensions - can be sprayed particle-free and only precipitate metal nanoparticles when exposed to heat. I prefer this method relative to direct particle spraying, as long as this solution is affordable and a temperature can be reached that enables a precipitation of the same material as the layer has -and precipitates already before sintering, i.e. immediately after striking the layer balls, e.g. via an exothermic reaction by ingredients in the spray solution and subsequent irradiation. XJet inject a metal dispersion with nanospheres, which melt at around $300\text{ }^\circ\text{C}$ due to the favorable surface/volume ratio. This method of filling in gaps is interesting. XJET specifies the shrinkage at approx. 16%, a perfectly acceptable value for the layer ball gaps.

The drawing shows the basic transformation from the layered ball to the compressed pressure part.

As an example, jetted approx. 50 nm big silver balls are shown, which could be sintered within 120 minutes at $150\text{ }^\circ\text{C}$. This picture contradicts the chart of a Fraunhofer institute shown on the next page, which implies that it has to heat AG nanoparticles with a diameter of 50 nm to almost $900\text{ }^\circ\text{C}$. The possibilities according to the picture are very interesting: Probably titanium derivatives could be sintered at a slightly higher temperature than $150\text{ }^\circ\text{C}$, but

still during printing to keep the layer balls individual! No constant temperature and monitoring would be necessary, i.e. no standing heat fields in the lid like HP's Jet Fusion, for example, but the jetted dispersion can contain, for example, a substance that optimally absorbs the surface beam of the passing wave emitter and then the necessary one generates heat so that the dispersion may no longer have to initiate an exothermic reaction chemically. The advantage of the Hyperfusion system is that the next "hot shower" of the subsequent layer occurs at a much shorter interval, instead of every 7.5 seconds as with the Jet Fusion, only about 100ms are required. The subsequent heating certainly extends down a few layers, so that sintering in my opinion is expected. This procedure should be tested. The dispersion should show a Ohnesorge number (viscosity to density, teardrop shape and surface tension) between 0.1 and 1 and of course not let the print head corrode. Hyperfusion would like to use filled dispersions, as we will see shortly, and suggests here using a dispersion with nanospheres, preferably of the same material or even with a $T_g > T_m$ of the layer spherical material, so that the empty volume should not be regarded as an acceptable evil, but instead according to every binder method, welcome the fact that these gaps are used to produce a ball-holding structure, but not (exclusively) with adhesive to be dissolved before the sintering process, but instead with material of the same layer ball, which now melts prematurely during the sintering process due to the much larger surface/volume ratio and creates a connection between the layer balls. As a result of the Laplace curvature pressure, compressive stresses arise in a convex spherical surface. The tension in the structure provokes a local excess of vacancies, which is compensated in the form of diffusion by material transport. The liquid phase of the small, jetted, first melting balls is drawn into open pores by capillary forces and significantly facilitates compression.

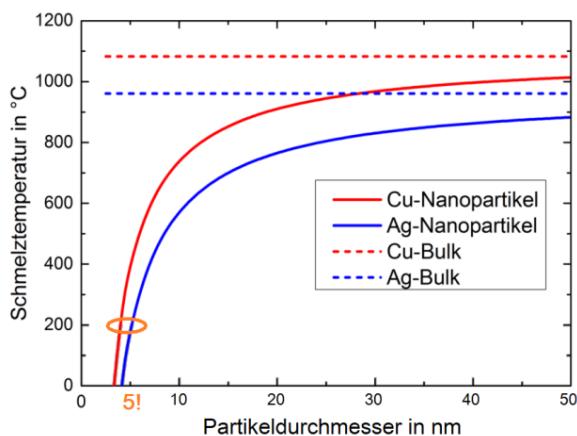

Schmelztemperatur in Abhängigkeit der Partikelgröße für Silber- (blau) und Kupferpartikel (rot)

The chart shows the silver and copper diameters required to melt these metals at 200 °. This favors the idea of the integrated current conductor in, for example, PA12 components, i.e. PA12 layer balls and the use of special pressure bars (e.g. every 10th) that could be made of copper. If the dispersion produces an exothermic reaction to approx. 200 °C (e.g. initiated by radiation) that sinters the copper or silver sheet during printing, no post-treatment of the plastic product would be necessary. However, the previous picture shows that much lower temperatures may already be sufficient. So here are several options to be tested. To prevent clogging, it is always important that the jet dispersion contains 100x smaller balls than the jet nozzle is large. HP relies on

fourfold redundancy, so it knows exactly that its solution produces clogging and visually checks the head row. The Hyperfusion printer has to be given a cleaning system, even if its sheer number of print heads provides considerably more redundancy than any other printer. Otherwise the performance would suffer.

SEM image of cross-section of a 316L stainless steel test specimen produced by an HP Metal Jet printer¹⁰

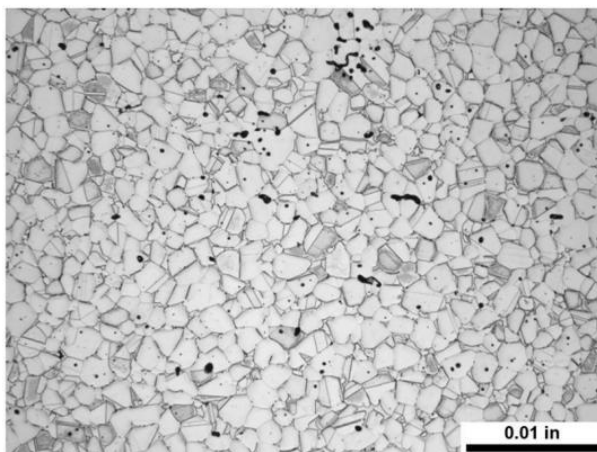

Let's come back to the sintering temperature contrasting EBM's 975 °C for IN718: already to increase the volume density, binder products have to be treated much hotter, for example to approx. 1260 °C with a gradient >10 °C/min, so that there are no porosity-promoting Laves phases. Binder sintering therefore uses a method of super solid liquid phase

sintering. If the solidus temperature is exceeded, a first liquid phase forms within the low-melting structure phases. The liquid phase that forms in the particle wets the still solid particle components and forms sinter necks at the particle contact points. Depending on the respective ball diameter, a 30-40% liquid phase at 1290-1330 °C could be used. It seems that the approach of spraying binding agent dissolved in the oven should contain carbon of more than 1 weight percent to prevent Laves phases is worth investigating. Smaller ball diameters than the above/suggested 60µm down to 20µm will bring even better results, but at the expense of printing speed, and I am not sure that the quality improvement is worth tripling the printing time. In the end result, of course, we would like to maintain a rectified structure that can be measured with HP's analysis. As HP's grain analysis of the sintered product already shows, the grain distribution is very isotropic.

In comparison, HP's analysis shows the anisotropic position of an SLM product with its symptomatic welding pools and welding lines with the typical long grains running perpendicular to the welding line, which indicate that the product cannot be loaded equally in every direction. I am happy to support HP's analysis with the 2.5D representation of another graphic. At least the stratified columns are epitaxially aligned with the melt bead.

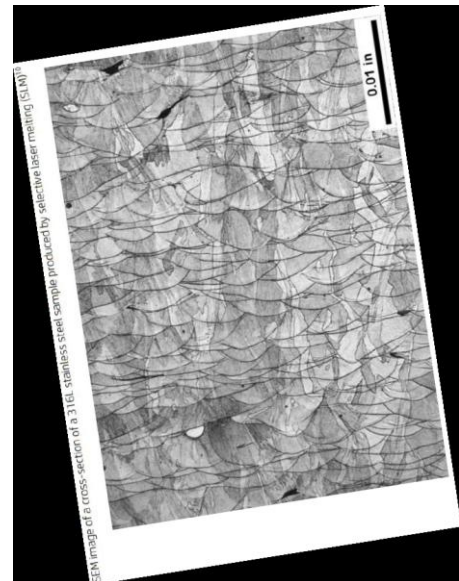
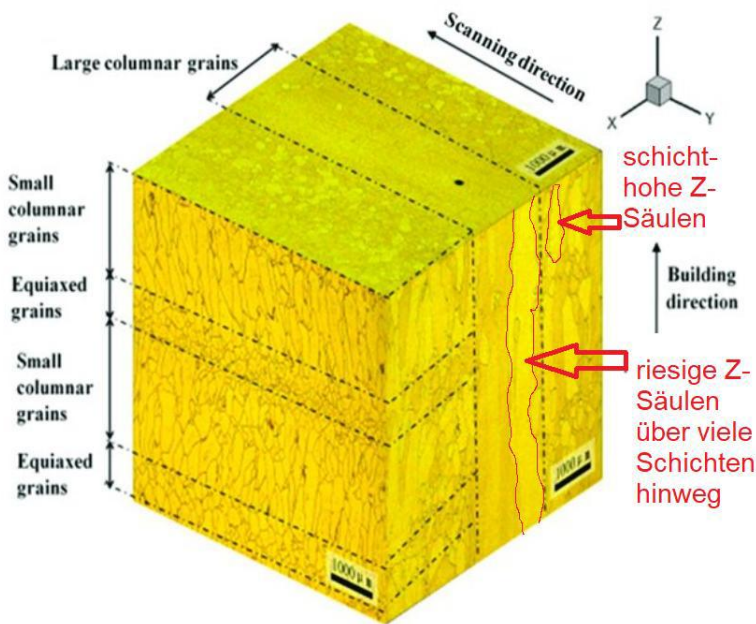

The clearly designed Hyperfusion process of

the jetting nanospheres onto the homogeneous layer of spherical morphology allows a much more predictable picture with the desired reproducibility of 3D printed products! Of course, it is useful for the research phase to separate the binder removal phase from the sintering phase, but later single-phase sintering should be the goal.

The picture above from a study by Wheat/Vlasea et al shows that there is still a lot to do: shrinkage and anisotropy were high here at 70% material density - and they were proud of 70%.

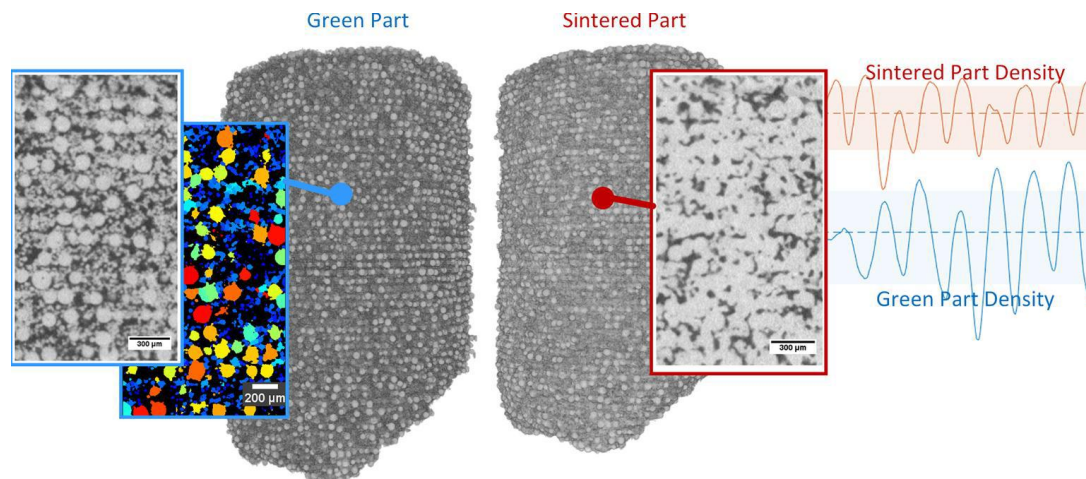

HIP

As mentioned above, the HIP process is a very nice process to minimize porosity:

Hot isostatic pressing (HIP) is a process that uses isostatic pressure applied on all sides at sintering temperature. The aim is to achieve complete compression at the set temperatures. The pressure applied to the outside of an evacuated sheet metal capsule is chosen to be higher than the heat resistance of the material, which leads to plastic deformation due to creep and diffusion processes of the individual powder particles. Inner pores are closed and any residual gas that may be present dissolves in the metal matrix. Due to the long process times at elevated temperatures, the structure should now change due to segregation.

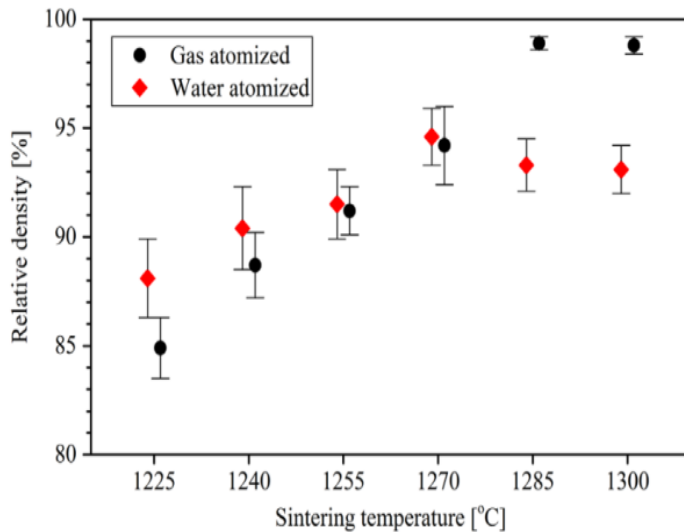

Whether hip delivers much better quality than pressure-free sintering specifically for sintering after a Hyperfusion process has to be investigated. The ball diameters also play a not negligible role, porosity can vary considerably, depending on the material and ball size. The best parameters can only be determined empirically, a volume density of 99.9% of HIPed binder products has already been proven, HP confirms >93%. I assume that at least the elongation at break is improved. However, the next graphic shows very nicely that the powder production process and the sintering temperature influence the density sufficiently.

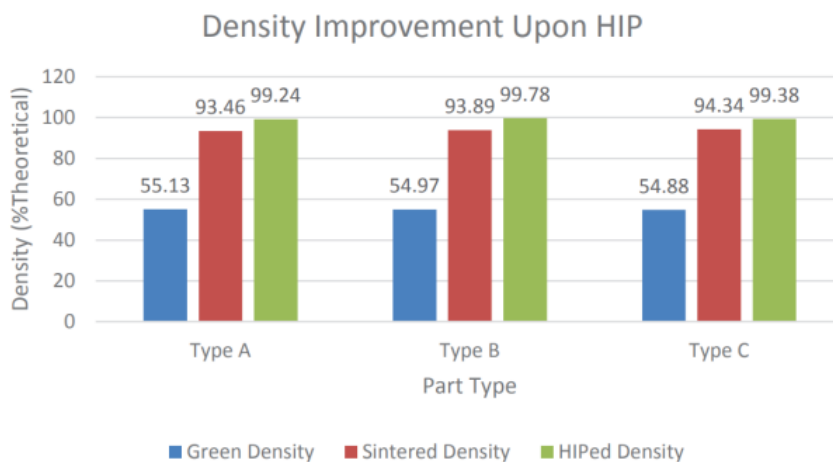

Of course, the entire printing/sintering process should be automated. Therefore, the post-print green compact must be strong enough to survive automated "decaking", which the modified Hyperfusion binding should achieve now. An automatic transfer to a perforated drum is then provided, in which the powder is largely removed by internal overpressure and external negative pressure before larger sinter temperature-resistant balls are fed into

the drum and the process described above continues. These balls are used to protect the printed parts against hitting one another too hard. The further automated process consists of transferring the contents of the drum with the large balls into the sintering furnace. Only the cooled object is briefly handled manually.

We want to leave the field of post-processing and turn to the printed part.

From the analysis of the weaknesses of the single-phase systems shown above, which use suboptimal temperature gradients during printing, I come to the conclusion, like HP, Desktop Metal et al, that the revival phase of binder jetting has now begun. Sometimes your own view coincides with the zeitgeist. Binders seems to be "IN". Z-Corp> Voxeljet> ExOne> HP> Desktop Metal> Hyperfusion? Like HP, Desktop Metal also had to postpone the start of sales, things are a bit more difficult in detail, especially if you want to add a magnitude or two of performance. So HP is 10 times faster than a SLM printer as defined by HP, Desktop Metal is now beating HP by leagues, and Hyperfusion wants to be over 100 times faster than HP. How can this work, especially since other weaknesses have yet to be eliminated, and what is that good for?

Let us first refer to the creation of PA12 print objects, because neither HP's Metal Jet nor Desktop Metal's metal printer are on the market and I cannot find any reliable values, sometimes Desktop Metal's production system prints 8.2L/h, times 12, and the construction volume has changed again ...

HP claims to be able to print ten times faster than conventional PA12 comparison machines. The printing process for a construction volume of 4.2 liters takes one hour. This printing speed is far below that required to use 3D printing industrially. Instead of 7.55 seconds per shift (approx. 1/10 square meters), 400 ms per square meter would have to be achieved. In addition, the powder reuse rate of 20-50% enforces additional mechanics for powder mixing, but unsintered powder with fresh powder, whereby, of course, five-times mixed with twice-used powder becomes indistinguishable from it, so that expensive powder must be discarded because the product volume-to-construction volume rate rarely exceeds 10%. In addition, the product strength suffers from the high empty volume that arises between the balls, the surface often appears rough, matt and poorly detailed.

6. The Hyperfusion procedure in detail

The task of the Hyperfusion method arises from all the problems described above: How can you print a hundred times faster, increase the strength through material compression, leave the print material recyclable, print object-detailed and make the object surfaces appear smoother and less matt?

A drum brings the speed required to print many times faster than previously possible.

Compared to conventional two-circuit systems (first wipe, then sinter), the drum printer offers great advantages. Until now, it was hardly possible to create a layer every ten seconds, now one layer per tenth of a second is possible, possibly even several.

In the process of continuous Hyperfusion printing by means of a drum (8, the numbers in brackets refer to the first drawing), it is provided that the layer pressure takes place in the form of a partial circle around the drum outer wall. The slide (print bed) (3) is continuously removed by one layer thickness during layer creation. If the powder is fed from an external reservoir (10) to the drum (8), the object consists of only one material. However, if each layer receives its powder from tanks inside the drum, different materials can be connected in layers. However, the unsintered powder would be mixed in the pressure chamber and would probably be unusable. The Hyperfusion drum printer with external powder supply therefore makes sense, with different material properties (e.g. electrical conductivity) being feasible by means of different material properties of the printing fluids. The printing does not require any support structures, but does not allow closed objects.

In contrast to DE102018006091.9, the drum printer for powder, which has to be melted by the wave emitter located in the drum, this printing method does not provide for heating of the powder. It is laid cold. This fulfills one of the three tasks: **The powder material is 100% recyclable**. The Melt Flow Index MFI, which can be quartered when the powder is heated several times, no longer drops.

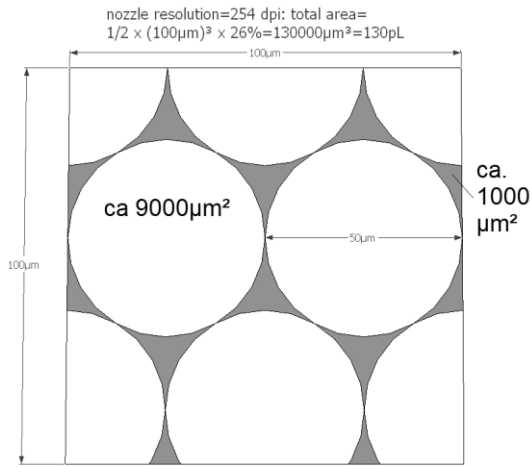

Figur 3

layer balls largely retain their geometry, the dimensional accuracy is significantly improved, as is the level of detail. The filling of the normally light-absorbing empty volume now ensures smoother and less matt surfaces. This means that other important tasks are fulfilled:

If one sphere is four times adjacent to the other (sphere in cubes), the empty volume is approx. $1 - \pi/6 = 48\%$; If layering is optimally hexagonal in the room (highest ball packing density), it still drops to a remarkable approx. $1 - \pi/(3\sqrt{2}) = 26\%$. This weakens product strength and post-processing sintering inevitably leads to dimensional accuracy problems. If you want to solve these two problems, the empty volume has to be filled up, meaningfully with the same layer material by two to three magnitudes of smaller volume. Due to the advantageously larger surface-volume ratio of the much smaller spheres to be sprayed on, the energy balance changes: the small spheres require less heat to fuse together. They now form a lattice structure around the large layer spheres and fix them (they can possibly also partially melt - advantageously even the underside of the sphere of the subsequent layer, which will soon be put on). Since the

The method of filling up now fulfills the tasks of compacting, achieving higher product strength, attention to detail, dimensional accuracy and less matt, but smoother surfaces.

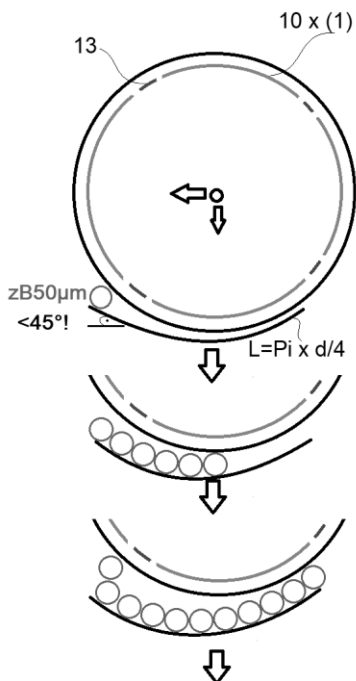

Figur 5

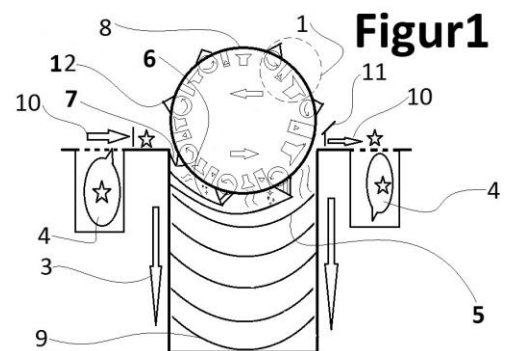

Figur1

The layer creation, which is faster by magnitudes, is achieved by the dispersion to be sprayed consisting of **microspheres** (approx. 1 μm maximum, since the print head openings are <100 μm and the printing material to be jetted should make up <1/100 of the opening), single-digit nano range only necessary for metal, here however, depending on product material components (e.g. PA12 as base body, silver as electrical conductor or other metal for the purpose of material stiffening) rather within a range of 5nm, so that e.g. silver particles melt at approx. 200 °C without destroying the PA12), **initiator and reaction**

liquid when irradiated by the drum built-in wave emitter starts an exothermic reaction within less than $50\mu\text{s}$, which can theoretically run indefinitely, but I would like $>2\text{ms}$, so that the above-mentioned subsequent layer of the next layer can easily be melted on its bottom, see Figure 4. In contrast to conventional HSS printing method, an attempt is not made to sinter the large layer balls, and the heat supply process should NOT be explicitly ended with the wave emitter passed. The radiation process is only the reaction initiator, the reaction continues independently of it. **This enables much higher speeds of the printing units (roller/spray heads/shaft emitters).** They are so high that planar-moving direction-alternating methods have long exceeded their physical limits.

It is therefore provided in the device for this method that at least one powder-distributing return roller (12) is in constant contact with at least one layer (5, 6, 7) in the printing area, but several and simultaneously created layers are possible and sensible.

The lying rotating drum fixed in XYZ has a diameter of approx. 1.4m and the print object has a layer length of approx. 1.11m (depending on the pouring behavior of the powder, here 45° is assumed as the limit), so that the overall length is one meter; the print width is specified as 260mm (2 print head rows, each with 2 print heads), the layer speed is set to one layer per second, depending on the variety of materials and color mixing, printing can be faster or slower.

With a drum perimeter of over four meters and a required installation width of the 260mm long roller, print head and shaft emitter unit (Hyperfusion unit) of 10cm, 40 Hyperfusion units (plus any special units for colors, cooling, variety of materials, etc.) are installed in the drum. The distance between the outer wall of the drum and the top layer of powder should ideally be minimal and is set to 1mm, which results in a construction volume of $0.8\text{m}^2 \times 0.26\text{m} = \text{over } 200\text{L}$ for a curved bed that can be lowered 0.8 meters deep. Both the roller and the print bed move down by a layer thickness of $50\mu\text{m}$ within one second during the 1.11m long layer creation, but layer thicknesses between 30 and $200\mu\text{m}$ can also be set.

This eliminates the disadvantages of the prior art and achieves the following advantages:

1. cold powder layering enables full powder recyclability.
2. approximately 2000 times faster than the references given by HP for Jet Fusion, or based on HP Jet Fusion, here based on the layer area, over 200 times faster.
3. higher material strength through material compression (Gap-filling)
4. visually less matt and smoother to the touch Surfaces.
5. more attention to detail because layered balls have their shape to keep.

Description of the Hyperfusion:

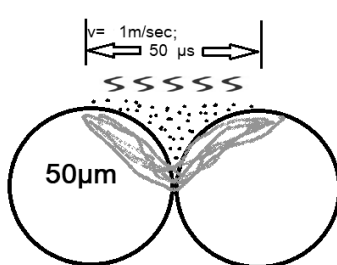

Figure 4

The drum (8) rotates unaccelerated during printing. The powder (4) is, as is conventional, supplied externally (10).

As many rollers (2) -print head (1) -wave emitter units [shown overall as (1)] can

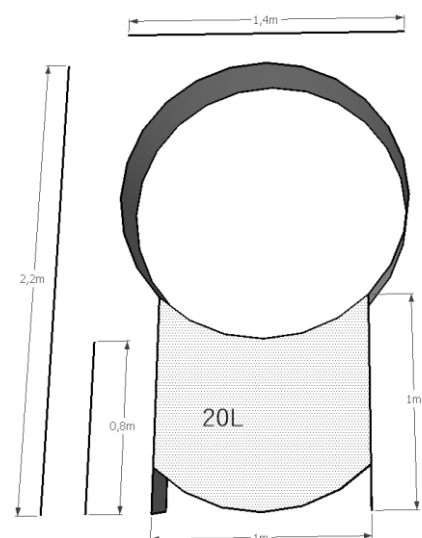
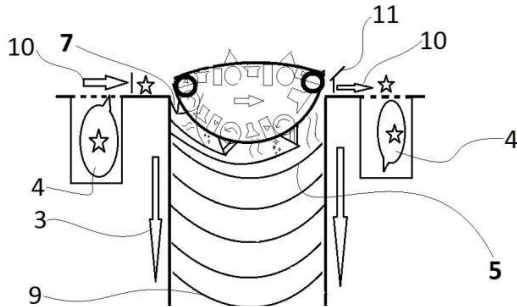

Figure 2

be cascaded as can fit in the drum (8) or makes sense. Important for the continuous lowering (3) of the print object by a layer thickness (5,6,7) per pass of a printing-irradiation roller unit (1) is a slight printing bed offset by one layer ball diameter in the direction of the powder feed, see Figure 5. This enables the printing units be installed stationary together with the rotating rollers, since the continuous lowering of the printing bed always ensures a sufficiently spherical layer spacing. The drum angular velocity (layer formation time) depends on the ball layer laying and printing speed and the reaction initiation energy transferability of the wave emitter (material, response to the wavelength, energy dose, etc.). Additional rows of print heads behind the first are favorable for cooling and object separation from the support material. The temperature controllability of the installation space results from this, but it is also facilitated by the use of the drum in such a way that there is now significantly less air volume in the machine above the printing bed and the sequence of the exclusively one-sided layer creation takes place many times faster, so that temperature fluctuations are minimized. For the purpose of external powder supply (10), a feed roller with 1-5 chambers, for example star-shaped, is formed, which contains somewhat more (for example 3%) powder per chamber than is necessary for the layer. The excess powder is pushed into the powder reservoir by means of a scraper (11) with, for example, a star-shaped roller.

Figur 5



Figur 3

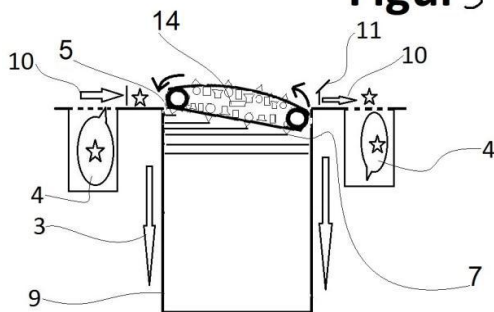

Figur 4

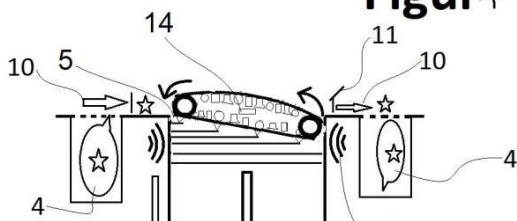

Figur 6

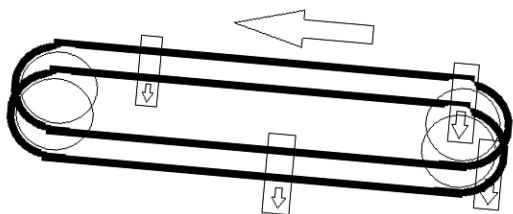

In contrast to conventional sintering processes (SLS & HSS), no energy is required for the targeted melting of the layer balls. As far as possible, the empty volume is filled with advantageously layer-like material (advantageously its $T_g > T_m$ of the layer material) including initiator and reaction liquid, whereby the much more favorable surface volume ratio of the microspheres, which are smaller by one and two magnitudes relative to the layer-ball volume, are much less. Melting energy can be calculated. This energy comes from the sprayed-on liquid, which initiates an exothermic reaction due to the initiator irradiated by the passing wave emitter and runs for more than two to four magnitudes longer than the irradiation period of $50\mu s$, for example, so that the next layer placed above the hot field can melt on the underbody.

Overall, the most complete possible empty volume melting of approx. 20-30% of the print object results in one lattice structure, which encloses each layer ball individually at its respective position as fully as possible, whereby it is to be assumed, as is also desirable, that the reaction temperature and the molten microspheres also thermally attack and partially melt the neighboring layer ball surfaces.

Figure 5 shows that the print head return does not always have to be circular, with a "caterpillar chain" one could save printing units, even more with a planar continuously lowering print bed and a chain lowered by the layer height, as shown in Figure 3 on this page. The print units can either be transported upside down as shown here, or according to the paternoster principle, so that the print head always points downwards, as shown in the image in FIG. 4.

Incidentally, the optical print head checking unit is indicated in the middle. It can also be external, and a robot could outsource defective units. In addition, the arrangement of the printing unit does not always have to be roller> jet> wave emitter, it could also be: roller> jet> jet> wave emitter> jet> wave emitter or another order, so maybe it makes sense to fill the layer ball gaps in several phases, sometimes with and sometimes without radiation, so that the dispersion can have a deeper effect. The vibrators are also indicated around the upper edge of the printing table, so that the compressed layers allow a greater printing depth.

Figure 6 again shows the paternoster principle (approx. 1/3 production cost savings compared to the drum system) with the always vertically aligned units. It should be noted that the print heads use the "backfire" principle, i.e. they are installed offset to the direction of travel, so that the drop experiences a vector facing backwards and hits with $V_x = 0$, so that the drop in X (at least 1.11m/sec aimed) is prevented.

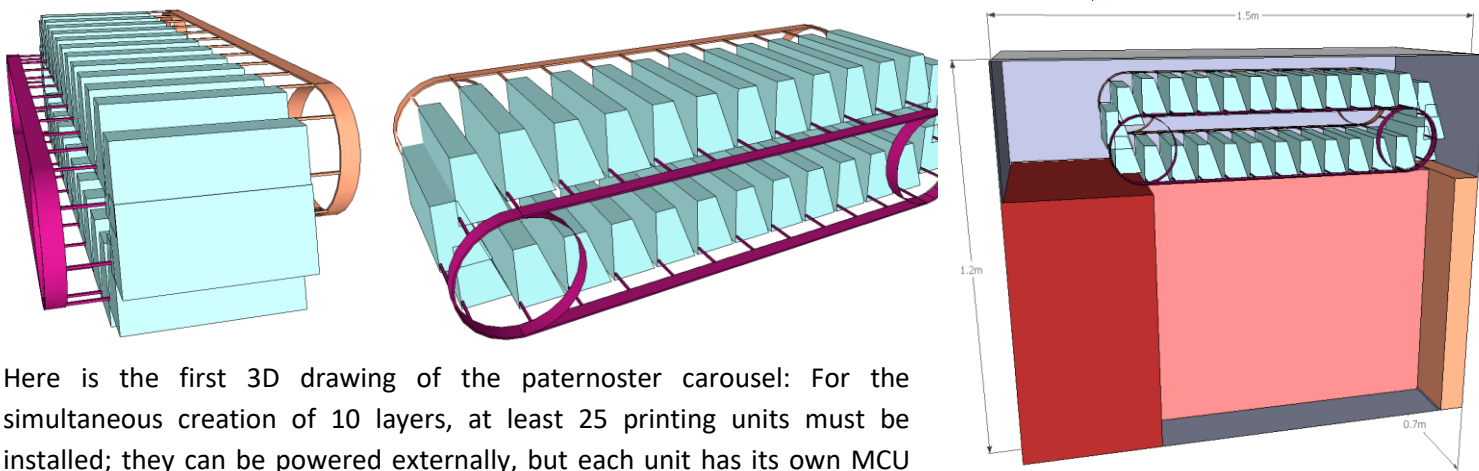

Here is the first 3D drawing of the paternoster carousel: For the simultaneous creation of 10 layers, at least 25 printing units must be installed; they can be powered externally, but each unit has its own MCU with e.g. wi-fi module, battery, roller, two offset print headers and the wave emitter. Assuming a product volume of 3% with 1/3 filler to be sprayed, which in turn contains only 50% melting beads, with 25 active pressure units and 200L construction volume each suspension tank of a pressure unit must contain $200L \times 3\% \times 3 \times 2/25$, so 1.44L, at approx. 9cm X-depth with 28cm Y-pressure bar length, this printing unit would not have to be 7cm high, but here 10cm are shown. Next to it a first sketch of the printer.

Conclusion: The unidirectional drum or chain movement, layer ball laying of cold balls, the use of modern print heads and the exothermic reaction, which only requires initiation radiation as "initial ignition", enable the fastest system-wide powder printing. With a quarter drum rotation per second and the use of a quarter of the drum perimeter for the layering of spheres with ten simultaneously active (layer-laying) units of 10cm width plus four possibly special units for colors, metals etc., evenly distributed over the entire perimeter, one layer formation per tenth of a second can be expected. Based on a construction volume of 200L with 1m length (X) x 0.26m width (Y) x 0.8m depth (Z) and a layer thickness of e.g. $50\mu\text{m}$ by means of layer balls with a diameter of $70\mu\text{m}$ for example, the entire installation space consisting of 16000 layers is printed with 100ms layering time within 1600 seconds or just under 27 minutes. Depending on post processing, component complexity (saved assembly work) and component size, 3D printing can be faster than injection molding for the first time. Based on a layer creation time

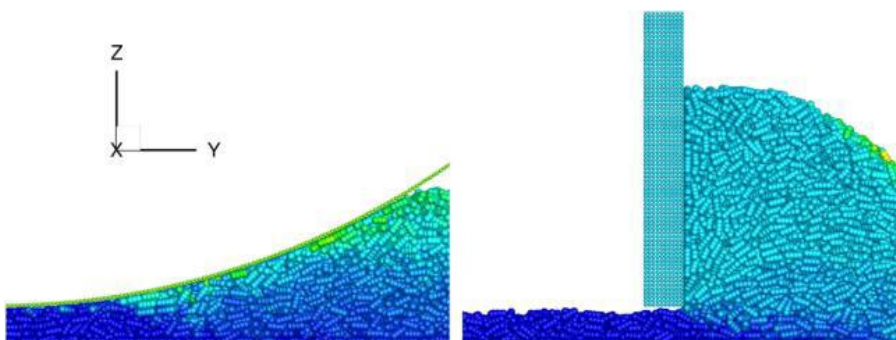

of 7.55 seconds of an HP Jet Fusion 4200 printer for a layer area of approx. 38cm x 28.4cm ~ 1080cm² ~ 143cm²/sec, Hyperfusion prints with 111cm x 26cm = 2886cm² ~ 28860cm²/sec over 200 times faster.

Equipment	Material	Sintering temperature (°C)	Relative density (%)	Ultimate strength (MPa)	Failure strain	Hardness
ExOne M-Flex [83]	Inconel 625	1280	99.6	612	0.41	237 (HV)
		1290	98	588	0.45	195 (HV)
		1300	97.9	522	0.356	185 (HV)

This statement now applies to plastic printing, and it should be used with caution insofar as it assumes the printing and laying process at 1.11m/s. I have already shown above that Desktop Metal only runs at

20cm/sec, the Integra P400 from EOS, however, already at 40cm/s and the build depth is only about 1/3 of the Hyperfusion machine. The difference is due to the following considerations: All providers are currently still

Table 4: 316L mechanical properties [1, 5, 6].

Additive Manufacturing Process	Ultimate strength, MPa	Yield Strength, MPa	Elongation at Break, %	Hardness, HRB	Density, g/cm ³
BJ	517	214	43	66	7.7
EBM [1]	509 ± 3	253 ± 3	59 ± 3		
DMLS [5]	482	172	30	77	
MIM [6]	450	140	40	67	7.6

working with chaotic powder, the big balls stumble over the small ones, the flow is inhibited. Several balls are pushed on top of each other in a layer. This procedure contradicts an orderly, predictable course. On the other hand, I want a defined ball height

(e.g. 55-65µm) and only one ball in Z per layer. A vibrator system is supposed to keep the construction container in constant vibration by attaching several vibrators per wall/floor (e.g. - + 10µm), so that the balls settle quickly and achieve a high packing density as well as a greater installation space depth. In the case of metal balls in particular, depending on their mass and the slope (e.g. print bed length = ¼ drum perimeter), it can be assumed that the balls press towards the center of the bed and thus support compression. The effect can also have a negative effect and must be confirmed empirically.

Layering is given special attention in the Hyperfusion process: Discrete Element Modeling (DEM) has to determine the optimal roller diameter (I am assuming an extremely small one here), the angular velocity in relation to the material and size-related properties and, of course, the laying speed. Here, the unimodal distribution should reach the targeted 1.11m/s with about 80% of a ball height per layer height. The bed vibration described above is said to contribute to greater density, in my opinion a roller compression vector is not necessarily an advantage, this has to be examined for the arrangement described. The graphic shows two laying methods, which in my opinion should not be used.

The two tables above show that binder processes do not have to be inferior to the MIM or SLM/EBM methods in terms of strength: here, a density of up to 99.6% is achieved with promising limits.

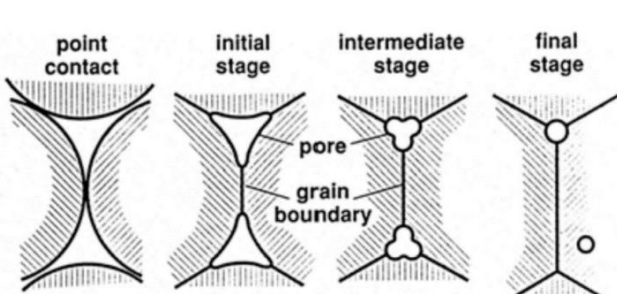

A lot depends on whether the balls can melt together and the gaps are eliminated during sintering, as the sketch shows. Otherwise, the calculation of oversize production will be exhausting, as the following two graphics show:

Each material shrinks differently depending on the product size and vector, so that we only work in the "near net shape" window, and post-dimensioning is necessary.

Another Hyperfusion patent goes into more detail on the idea of keeping the installation space unheated, but this

time putting the powder hot to save the wave emitter behind the print head:

Hyperfusion: Continuous-hot-laid-micro-melt-compressed-3D printing of sinterable metal, plastic or ceramic powder on an unheated powder bed using a print head carousel.

The invention relates to a method and an apparatus for Hyperfusion, the layer-by-layer production of three-dimensional objects, in particular layered flat by means of a print head

carousel for the purpose of simultaneously creating multiple layers with continuous Z-table lowering, the powder bed balls being **binder-free, without bed heating and without wave emitters** (trailing the print head, if applicable), specifically locally connected, so that hot-melted, micro-melt-compressed 3D printing of sinterable metal, plastic or ceramic powder on unheated powder bed is possible.

State of the art

The patent specifications DE102018010015.5, DE102018008594.6 (Hyperfusion), DE102014019392.6 (SLA), DE102016002598.0 (SLS) as well as DE102016015617.1 (granulate) and DE102018006091.9 (HSS) already use drums for the purpose of building layers much faster. In DE102018010015.5, however, a carousel was used instead of a drum to print planar instead of curved, and the saving of printing units (possibly rollers, print heads, wave emitters, etc.) was over 30%. Powder laying on an unheated powder bed saves complex temperature control in the pressure chamber.

However, the latter patent may require a wave emitter, for example in the form of an IR heating strip for the purpose of transporting the energy of the heat radiation (heating/melting), for example on PA12 bed balls, known from HSS applications. It is also possible to initiate a chemical reaction with sprayed-on substance using UV strips. In any case, energy transfer to the powder bed is required behind the print head, unless you are satisfied with cold bonding using e.g. phenol, which, however, requires de-bonding, i.e. an intermediate step after the printing and before the sintering process, whereby it must be mentioned that just like any gluing process that introduces non-powder bed additives it is subject to the binder dissolving/decomposing step, which is why almost binder-free printing (e.g. HSS & HPJetFusion) appears advantageous. Now, however, the energy transfer following the jet process for powder bed ball melting would have to be omitted. In addition, the properties of the Hyperfusion patent are to be retained, i.e. the powder bed, in contrast to HP JetFusion/Metal Jet and other bed temperature-controlled processes, should remain cold, and of course the powder bed should be continuously lowered by moving the print heads in one direction only.

Object of this invention

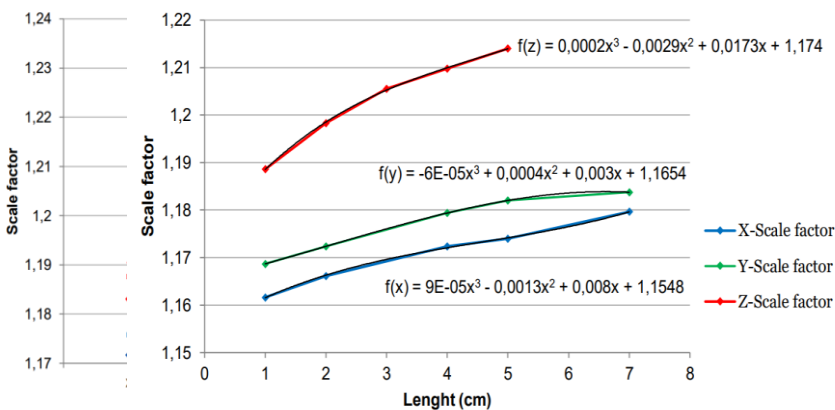

The task of this invention now arises from the above-described problem: how can the powder bed balls be caged **binderless, without bed heating and without wave emitter?**

Disclosure and description of the invention: Basic structure with essential features according to the invention

The powder discharge is spatially (and therefore also temporally) directly linked to the spraying process: A bed attached directly to the print head contains the bed powder. A carousel device that enables a continuous lowering of the print bed by unidirectional print head movement over the powder bed therefore requires as many powder ball tanks as print heads connected to them. This theoretically allows material mixes, but the unprinted powder is mixed and difficult to sort. The generally counter-revolving roller distributes the balls. These are heated by having to pass through a (tapering) gap between the heated tank wall and the heated roller. The gap through which the balls finally fall onto the print bed is one ball diameter wide, the lower tank level is adjustable vertically to about 0.5 ball diameter to the print bed. Depending on the ball material, e.g. PA12 (T_m 180 °C) or a metal (T_m 1200 °C), the balls are heated to 150 °C or 500 °C when they slide out of the tank onto the print bed. The distance between the powder tank outlet and the print head nozzle is preferably 20 mm. The forward speed of the print head is 0.5 m/s for a given device. In this case the sprayed dispersion reached the hot balls within 40ms. Until the sprayed dispersion hits the print head, the hot balls now lose thermal energy from the environment, i.e. the underlying ball layers, of an assumed 10%. If TIJ (bubble jet principle, much cheaper manufacturing process than PIJ) is assumed, the sprayed dispersion would contain a very high proportion of water, up to 90%. The water would then evaporate without an additional heat source, so that no radiation after the print head/preceding radiation would be necessary. The task of the dispersion is to transport nanospheres, preferably, of course, powder material of the same material then print bed layer.

However, the use of larger balls up to half a magnitude of the powder bed ball diameter (roughly corresponds to the size of the tetrahedron hole with optimal ball density) is cheaper and therefore also worth considering, but the dispersion ball diameter should not exceed 1% of the jet nozzle diameter of the print head, so that said dispersion ball would probably remain at a maximum in the upper nano range. The material of these balls, which are a hundred times larger, could no longer use the nano-effect and would therefore have to have a favorable T_m (for example $< \frac{1}{2} T_m$ of the powder bed balls). The matrix (lattice structure that encompasses the powder bed balls) should not be filled so that the powder bed balls can connect extensively during the sintering process. A complete or even large-volume filling would not be expected anyway and could only be achieved by running over several print heads without layering. This process is useful for the production of smooth, reflective surfaces. The shrinking process would now have an extreme influence on the dimensional accuracy, so that, as was previously the case with binding, despite excessive pressure and complex CAD anticipations, no uniform shrinkage can be expected for all axes and a "net shape" print is probably excluded.

When the critical surface/volume ratio is undershot, the nano-effect now ensures melting far below the T_m of the bed powder material. As the nanospheres are connected, the ratio mentioned is changed so that the T_m of the nanospheres increases, possibly even above the existing ambient temperature, so that the melting process is interrupted, but preferably after a further layer of powder has been laid so that the resulting matrix can also be shaped. This is favorable but in any case, when the static/lattice structure is no longer loaded, the above layer ball is already in place before the melting process is finished. With the device provided (carousel with 5cm spaced rollers and 0.5m/s feed), the next layer ball is placed after 35mm or 70ms at the latest. The dispersion should therefore evaporate and the nanospheres should melt 10-50% of the T_m of the latter, depending on the material, due to the ambient temperature of the bed powder spheres, which are a thousand times larger in volume ($7\mu\text{m}$

to 70µm diameter), until the nano-effect has been reduced by nanosphere fusion and the bed powder temperature has dropped. The process can still be controlled by the (almost effortless/free) indirect preheating of the dispersion in the print head tank, i.e. the choice of insulation material between the powder bed ball tank and the dispersion tank. With the PA12 (powder tank heating wire 150 °C at Tm180 °C to 80 °C nanosphere Tm, powder ball temp when the dispersion hits approx. 130 °C) the 50 °C over nanospheres-Tm hot powder balls would melt the nanospheres within approx. 2s , However, one should consider: The dispersion was heated up to a maximum of 60 °C in the tank. The insulation between the print head and the powder tank is made of plastic. The sprayed water first distributes the heat, but also cools the powder bed balls down to approx. 105 °C and immediately begins the evaporation process; the nanospheres now begin to melt until the decaying nano-effect (volume growth relative to the surface growing together) has brought the necessary melting temperature into line with the falling powder bed temperature. Therefore, the melting process is greatly shortened and will never take 2 seconds.

In the case of metal (powder tank heating wire 500 °C at Tm1200 °C to 300 °C nanosphere Tm, powder ball temp when the dispersion hits approx. 400 °C), the 100 °C above nanospheres Tm powder balls would melt the nanospheres within approx. 2s , However, one should consider: the dispersion was heated up to a maximum of 60 °C in the tank. The isolation between the print head and the powder tank is done by means of an air gap. The sprayed dispersion ideally consists of a low-viscosity liquid (TIJ heads, which require water-based dispersions due to the bubble jet principle, may have to be replaced by PIJ heads if oxidation of the nanoparticle cannot be prevented), which at temperatures above 200 °C evaporates (sprayed-on carbon, later dissolved in the sintering furnace, of more than 1 weight percent as a dispersion residue can prevent Laves phases); it initially distributes the heat, but also cools the powder bed balls down to approx. 350 °C and immediately begins the evaporation process; the nanospheres now begin to melt until the decaying nano-effect (volume growth relative to the surface growing together) has brought the necessary melting temperature into line with the falling powder bed temperature. Therefore, the melting process is greatly shortened and will never take 2 seconds.

This variant of Hyperfusion is described as a binderless process because the state of the art often defines the commonly used binder as sprayed adhesive, radiation-necessary resin or radiation-necessary heat radiation absorbers, so that always material other than printing bed powder is introduced, which often requires the de-binding step before sintering, and which is subject to residues that can reduce product strength. However, the goal of this Hyperfusion variant is the residue-free use of material identical to the printing bed powder without subsequent irradiation and without de-binder processes.

In the case of the device with continuous printing bed lowering with a printing length of 1m and unidirectional forward speed of the printing heads arranged at a distance of 5cm one behind the other, each printing head must be vertically arranged, for example 50 µm above the previous one, if the printing layer height is set to 50 µm.

Advantageous embodiments are given in claims 1-10.

The disadvantages of the prior art are eliminated by the solution according to the invention and the following advantages are achieved: **irradiation-free and bed heating-free and binder-free printing method**

Description of the drawings and preferred embodiment of the invention

The present invention is explained in more detail below by way of example and not limitation with reference to drawings.

Figure 1:

Unimodal powder is - preferably slightly electrically charged - in the powder tank biased in each print head. Behind the lower front edge, this has a heating element which is preferably also slightly electrically charged with the same charge and which, for example in the case of PA12, preheats the powder to approx. 140 °C at approximately 150 °C before it- preferably also charged with the same charge- due to a roller rotating in the same direction but preferably some percent faster- is rolled through a coned gap, where the roller has a softer surface than the heated roller. Balls rubbing against each other and uneven ball geometries with unequal diameters require the traction-enhancing heating element-roller spacing adjustment by means of at least one soft wall, shore A90 of the roller wall is proposed here. The electrical charge, which is directed in the same way everywhere, is intended to prevent the balls from sticking to the roller.

The heating element has a round edge at the bottom facing forward, which could possibly put the surface in order, but other edge shapes are also conceivable.

The heating element has a very sharp edge facing backwards, which should be positioned vertically by preferably less than half a print bed ball diameter, so that no balls can shoot forward and are limited by the top by the roller and at the bottom by the layer previously laid. The slightly over-rotating (perimeter unwinding speed, e.g. 5% above print head forward speed) angular speed of the roller now provides dynamic pressure and presses the balls against each other in the Y direction (lateral to the printing direction), so that the optimal packing density should be achieved. At the end of each layer, the roller is stopped or briefly turned in the opposite direction so that no more balls can emerge from the slot. When the print head has reached its layer start position, the roller is starts rotating. It is also possible to attach a board that regulates the height of the printing bed powder with a scraper edge that prevents adhesion behind the roller.

The balls are heated due to the hot roller wall - possibly around 150 °C for PA12 - and the heating element wall, which tapers around the roller from 10 times to a simple ball diameter - is heated to approx. 140 °C before it is moved during the further print head movement (with preferably 0.5m/s and about 20mm) cools down to about 130 °C. Now the print head (preferably thermal ink jet = TIJ, e.g. HP HP SPT EDGELINE/TIJ4 A51-53) passes over the print object location and sprays a water-based nanoparticle dispersion, preferably preheated to approx. 60 °C, which should contain as many nanoparticles as possible in terms of volume (preferably >10%). These particles should begin to melt at i.e. 80 °C. The sprayed water content should contribute to heat distribution before evaporation. Nanoparticles and layer spheres are preferably made of the same material. In any case, care should be taken to ensure that printing is carried out without residues and the de-binder process is therefore eliminated.

The printed layer cools further to 70 °C after the melting process, during which the layer ball holes have now been partially filled, before the next roller of the following print head -after approx. 35mm and 70ms- puts on the next approx. 140 °C hot ball, so that the cooling in Z takes place continuously after many printed layers.

The continuous lowering of the print bed is of course only possible due to the unidirectional printing movement by a carousel or a drum or similar.

Figure 2:

An example is shown here of a version and device that uses the print heads that are already used in 3D printers from HP. The powder tank consists of two injection-molded half-shells, the short outer sides of which hold the

battery-powered electronics indicated by boxes. The powder tank and TIJ head are only mechanically connected and can be snapped together using the powder tank support bracket.

Figure 3:

The device that drives the roller of the powder tank consists of a planetary gear motor with a speed sensor as a feedback channel. The output turns at 1430RPM. Another measure to improve quality could be a lateral roller movement (back and forth) over a ball diameter per print head travel speed, that is to say with the device of 50 μm laterally at 20 kHz. Transducers would be ideal here, but expensive, large, heavy and not for 100% ED (built for a period of use), cell phone vibrators are cheap, small and light, but also not 100% ED-compatible - and the frequency is far below the desired. The device installs both systems. In addition, the two long upper edges of the printing bed of the device are provided with a series of strong vibrators in order to generate short-stroke waves (<25 μm) which are intended to compress the layers.

The print head shows the five TIJ units, each approximately one inch long, arranged in two rows. Similar heads are used in many bubble jet printers as disposable items (when the tank is empty).

Figure 4:

The device shown consists of a combination of four gear-toothed carousels with three different running speeds: Carousel 1 as a printing system runs at 0.5 m/s, while carousels 2 and 4 are to move the print heads from one Z plane to the other. Carousel 3 ensures rapid return transport on the plateau before every 30th print head is pushed into the refill position outside the carousel system for a pit stop. A complete round takes about 3s, so the filling process can also take about 3s. Each print bed powder tank carries a WIFI-controlled battery-powered MCU, which receives the shift print schedule within less than 100 ms before each shift print start. The battery is charged within the approx. 3 seconds pit stop for the energy supply of the next 30 rounds x 2 working seconds = 1 minute of its connected print head system.

Figure 5:

Within the 3s described above, about 45cm³ of dispersion and about 150cm³ of powder must be transferred to the tanks.

The carousel system of the device constantly moves 30 heads, with an exchange taking place every second, so each head absorbs powder and dispersion for 30 rounds.

Figure 6:

The carousel system above shows two replacement print heads (on the right of the refill position) and one on the left, which must be removed from the system manually for repair. At the pit stop, there is a simultaneous bidirectional movement: while the almost empty printing unit is pushed into the refill position, the one that has just been filled runs back into the carousel after parallel offset. The replacement heads are automatically brought into the system if one head fails. During the filling process, the head can be cleaned within approx. 2 seconds; If the TIJ electronics still does not detect the development of bubbles in each port during test firing, the (always filled) replacement head is pressed into the filling position, which is why the previously negative-tested head is pushed into the repair position.

Figure 7:

The big brother of the (test) device discussed so far is also shown here: This device shows the same system of the same speed, but with ten print heads lined up next to each other, so that a volume ten times larger can be created: to the standard length of the test system of 100cm a printing depth of 80cm should now be 100cm printing width instead of 10cm. This would result in a print volume of 0.8m³ within the 27 minutes already known from the previous patent (16000 layers each 50µm with 1m print length 100ms). With an estimated product volume/print volume ratio of only 3%, approx. 0.05m³/h or approx. 1m³ of pure product volume could arise per day, i.e. **one** machine would consume approx. 250 tons of PA12 per year, for which HP4210 machines worth \$100 million would have to be purchased for the same conditions.

The principle

Basic representation of the printing methods for PA12 with trailing UV or IR bar. Polymerization is suggested for lossless reuse if debinding is possible at low temperatures. If you want to save on the sintering furnace process, the IR bar can be used.

The metal printing process does not require IR/UV strips and injects nanospheres of powder material with the dispersion. A polymerization process instead of nanospheres - then again with a UV bar - would be an alternative. Of course, the metal object is sintered in every case.

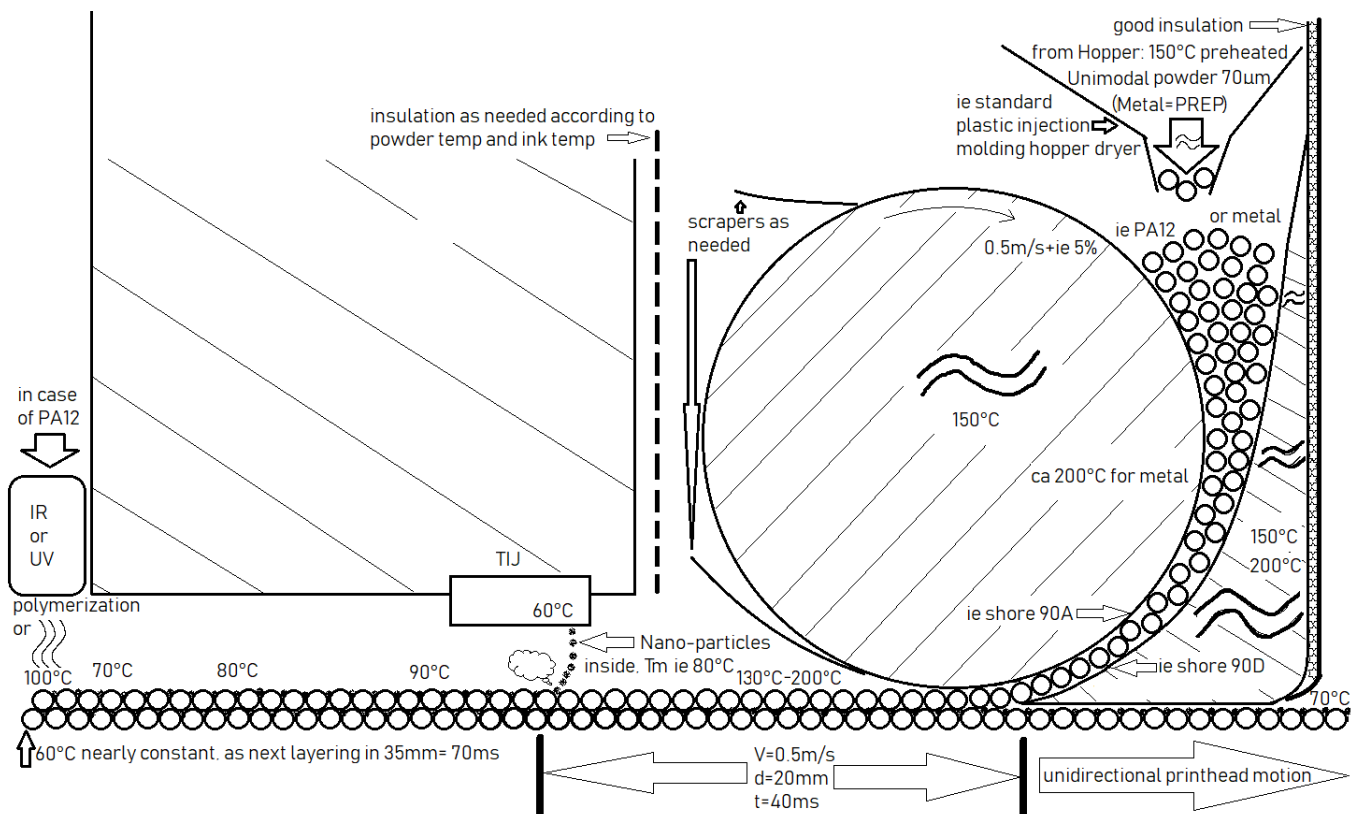

1.

The whole trick with this design is the fast sequence of laying and jetting: a standard hopper dryer heats the PA12 bed powder to, for example, 150 °C. The temperature is selected so that the e.g. shore A90 casing of the pressure

tank roller rolls the largest balls and rolls them cylindrically and each ball is adjusted to the standard diameter and thus facilitates transport between the roller and the wall (see picture below).

If the tank insulation keeps the powder in the tank sufficiently hot for the short dwell time, further heating measures in the roller and wall can be dispensed with.

Metal powder, especially PREP-made, is sufficiently unimodal. In both material cases, jetting is to be carried out, for example, as a radically activatable resin as an adhesive matrix. For metal - as we will see- the TIJ head can jet a water-based dispersion, since enough evaporation energy will be stored in the metal balls, the Hopper-Dryer temperature would be adapted to the respective metal in order to evaporate the sprayed water content.

Plastic, on the other hand, is adjusted to the diameter, but it will not be able to avoid the more expensive PIJ heads, since the high water content cannot be resolved even with trailing IR strips. However, the principle of jetting thermally free-radically activatable resin as an adhesive matrix is retained.

A few calculations:

Said residence time can be calculated as follows: 3s filling time + maximum 30 laps each 3s = 93s. The number of fillings per print is an estimated 75% (**all further calculations are based on 75% print volume usage and 5% product area relative to the maximum print area**) of the maximum possible print height of 80cm, i.e. 60cm, at 50 μ m layer height and correspondingly 12000 layers/30 rounds pit stop with 400 tank fillings, i.e. 13 tank fillings per tank per print; created within 1200s = 20 minutes at 100ms/layer. In this case, the ball diameter is theoretically $50\mu\text{m} \times \text{root}2 = 70.7\mu\text{m}$

Life time:

The chain systems: 12000 layers x 1m x 2 prints/h x 10h/d x 250d x 10y = 600,000 km for carousel 1, approx. 7 million km for carousel 4.

The carousel motor, the tank roller motor, the print bed stepper and vibrators: 60000h.

Hopper tank fill: 400 x 2P/h x 10h/d x 250d x 10y = 20 million.

Tank fillings per tank: $400/30 \times 2P/h \times 10h/d \times 250d \times 10y = 0.67\text{mio}$.

Prints: $2P/h \times 10h/d \times 250d \times 10y = 50000$.

Dispersion jetting per layer, starting from $18000\mu\text{m}^3/1000\mu\text{m}^2$ (calculated below): $18\text{pL} \times 1000 \times 108000 \times 5\% =$ approx. 100 million pL or 0.1cm³.

Dispersion jetting per print per print head: $0.1\text{cm}^3 \times 12000 \text{ layers}/30 \text{ Dk} = \mathbf{40\text{cm}^3}$. Ink tank is enough for a print, about 53cm³ for 16000 layers, with 5% object area.

Dispersion jetting per print: $3\text{cm}^3 \times 400 \text{ fillings} = 1.2\text{L}$.

Nanoparticles per print (at 7.3% solids content of 1.2L) = 88cm³.

Imprint area per layer: 5% of $1\text{m} \times 10.8\text{cm} = 54\text{cm}^2$.

Imprint area per print: $54\text{cm}^2 \times 12000 = 65\text{m}^2$.

Imprint area per day: $65\text{m}^2 \times 2/\text{h} \times 10\text{h}/\text{d} = 1300\text{m}^2$.

Of which created by a PH (print head): $1300\text{m}^2/30\text{Dk} = 43\text{m}^2$.

Imprint area per week: $1440\text{m}^2 \times 5\text{d} = 6500\text{m}^2$.

Of which created by a PH (print head): $6500\text{m}^2/30\text{Dk} = 216\text{m}^2$.

Imprint area per year: $1440\text{m}^2 \times 250\text{d} = 324,000\text{m}^2$.

Of which created by a PH (print head): $324,000\text{m}^2/30\text{Dk} = 10800\text{m}^2$.

Powder laying per layer: $1\text{m} \times 10.8\text{cm} \times 50\mu\text{m} \times 74\% = 4\text{cm}^3 \text{ max.}$

Powder laying per filling: $4\text{cm}^3 \times 30 = \mathbf{120\text{cm}^3}$. The powder tank therefore holds powder for at least 31 layers.

Powder laying per print: $120\text{cm}^3 \times 400 \text{ fillings} = 48\text{L}$.

Powder consumption per print: $120\text{cm}^3 \times 400 \text{ fillings} \times 5\% = 2.4\text{L}$.

Powder consumption per day: $48\text{L} \times 5\% \times 2\text{P}/\text{h} \times 10\text{h} = 48\text{L}$.

Powder consumption per week: $48\text{L} \times 5\text{d} = 240\text{L}$.

Powder consumption per month: 1000L .

Powder consumption per year: 12m^3 .

Powder consumption per life time: 115m^3 .

Powder intake per day (75%): $48\text{L} \times 2\text{P}/\text{h} \times 10\text{h} = 1000\text{L}$.

Energy consumption without heating device and without UV-IR strips, i.e. metal printer (Hopper-Dryer brings the entire heat supply): approx. 1KW: (e.g. carousel motor = NEMA86, 2Nm, 3000PPS half steps, bipolar, 60V, 5A, 300W; printer PC 300W; 2x Nema 57 bed stepper with total 200W gearbox - it can lift up to 700kg, 20 active Faulhaber total 40W, 20 active HP SPT EDGELINE/TIJ4 A51 total 200W?); Test system hopper dryer 220v 3KW 25L approx. 1000 €.

Discussion of the evaporation energy for i.e PA12:

Would a unimodal $70\mu\text{m}$ thick, $140\text{ }^\circ\text{C}$ hot powder layer within 40ms (e.g. 1s) retain enough water evaporation? And would PA12 nanoparticle melt energy to place a matrix around the bed powder balls without water residue? It may be beneficial that the next hot layer should be applied after 100ms. Packing density-optimized, each sphere surrounds one octahedron and two tetrahedron holes.

If we calculate with 70% to 30% based on $1\text{L} = 1\text{dm}^3$ (PA12 ball portion to hole portion), then 0.7 Kg PA12 balls with $1.8\text{kJ}/\text{kgK}$ are approx. **180kJ** in $140\text{ }^\circ\text{C}$ relative to the water portion to be heated up to $40\text{ }^\circ\text{C}$ 30% of 90% = 0.27kg in the dispersion preheated to $60\text{ }^\circ\text{C}$ with $4.3\text{kJ}/\text{kgK} \times 40\text{K} = 46\text{kJ}$ plus vaporization energy $2260\text{kJ}/\text{kg} \times$

$0.27\text{kg} = 610\text{kJ}$, plus PA nanoparticle content 10% of 30% to be heated up to $140\text{ }^\circ\text{C}$ 0.03kg in the dispersion preheated to $60\text{ }^\circ\text{C}$ with $1.8\text{kJ}/\text{kgK} \times 140\text{K} \times 0.03\text{kg} = 8\text{kJ}$, plus 10% of 30% PA12 nanoparticle melt energy $100\text{kJ}/\text{kg} \times 0.03\text{kg} = 3\text{kJ} = \mathbf{670\text{kJ}}$.

A hole filling in order to prevent shrinkage would be impossible, and an adhesive layer would not work either. Creating a Pa12 material of the same material cannot be successful with the PA12 powder due to the pure melting process without nano effects. Can cheap warm air with dehumidification in the inner carousel area help as an IR alternative for this system?

There would be much more favorable conditions for metal printing: The specific heat capacity between magnesium and silver is $1\text{-}0.2\text{kJ}/\text{kgK}$, with densities between $1.7\text{-}10\text{kg}/\text{dm}^3$. From titanium to iron alloys, the balls would be 4-8 times heavier than the PA12 and could now store $2.3\text{-}3.5\text{kJ}$ in volume instead of 1.8kJ .

The powder could also be placed hotter. However, depending on the particle diameter, the nanoparticle melting temperature might also be significantly higher.

If we reckon with 70 to 30% based on $1\text{L} = 1\text{dm}^3$ (steel ball part to hole part), then there were 5.6kg steel balls with $3.5\text{kJ}/\text{kgK}$ approx **3920kJ** relativ to water part that has been heated for ca $40\text{ }^\circ\text{C}$ 30% von $90\% = 0.27\text{kg}$ in the dispersion preheated to $60\text{ }^\circ\text{C}$ with $4.3\text{kJ}/\text{kg} \times 40\text{K} \times 0.27\text{kg} = 46\text{kJ}$ plus evaporation energy $2260\text{kJ}/\text{kg} \times 0.27\text{kg} = 610\text{kJ}$, plus steel nanoparticle portion to be heated up to $140\text{ }^\circ\text{C}$ 10% of $30\% = 0.24\text{kg}$ in the preheated dispersion to $60\text{ }^\circ\text{C}$ with $0.46\text{kJ}/\text{kg} \times 140\text{K} \times 0.24\text{kg} = 16\text{kJ}$, plus 10% of 30% steel nanoparticle melt energy $270\text{kJ}/\text{kg} \times 0.24\text{kg} = 65\text{kJ} = \mathbf{736\text{kJ}}$. The assumed $200\text{ }^\circ\text{C}$ steel ball temperature refers to the discussion on p.16f, where metal nanoparticle melting below $200\text{ }^\circ\text{C}$ was shown.

In order to fill holes for more visually appealing surfaces, one could now spray the print heads several times over the same layer in terms of thermal energy without creating a layer, so that the matrix would be more stable. But since the layers underneath have an excess of heat, you can fill up even more, a very nice effect!

The nanoparticles melt, but do not adhere to the "vertical" spherical walls, but lie in the spaces above the lower sphere. The sphere offers $50 \times 70 \times 70\mu\text{m}$ cube volume, said area would be about $5000\mu\text{m}^2$. A $70\mu\text{m}$ ball in a $245,000\mu\text{m}^3$ volumetric cube has a surface area of $15700\mu\text{m}^2$. Under given 30% packing density conditions, the surface would grow from 52% packing density to approx. 70% , i.e. by a factor of 1.35 to approx. $21200\mu\text{m}^2$, due to the surface proportions of neighboring spheres in the same cube. Thanks to the capillary forces, the portion to be wetted for the creation of the matrix is now around 10% , so that around $2100\mu\text{m}^2$ should be wetted. This corresponds to $400\mu\text{m}^2$ wetting on $1000\mu\text{m}^2$ printing area. How thick can the matrix layer be on average?

The HP SPT EDGELINE/TIJ4 A51 black printing TIJ head is shown with $9\text{pL}/\text{drop}$. 5280 openings per row on 108mm printing width with two rows in a row thus spray $18000\mu\text{m}^3$ to approx. $20 \times 50\mu\text{m}$ without any redundancy if a frequency of 20kHz is required (HP shows in videos that the HP SPT EDGELINE/TIJ4 A51 jets 150mio drops/s. With 10560 openings, this corresponds to 14204 drops/s/opening, i.e. $70.4\mu\text{s}/\text{shot}$. Depending on the dispersion viscosity - cavity replenishment - 20kHz are ambitious for this head, but the pure heating, outlet and mini-minus status process only takes $50\mu\text{s}$ in the video) ,

Starting from $18000\mu\text{m}^3/1000\mu\text{m}^2$, $18\mu\text{m}$ thick can be sprayed, less 90% water content, layers of almost $2\mu\text{m}$ thick should be possible. With $400\mu\text{m}^2$, which we only want to wet on a printing surface of $1000\mu\text{m}^2$, we get **$5\mu\text{m}$ thick matrix layers** if the capillary forces ensure that only 10% of the spherical surfaces have to be wetted. Below

we see pictures that show the hole volume between the 70 μm balls: It takes about 66pL for a complete filling, for a projected ball area of 5000 μm^2 . If the print head injects 18pL/1000 μm^2 , 90pL on 5000 μm^2 can possibly deliver 6600 μm^3 solid (with 7.3% solid content in the dispersion), which corresponds to 10% hole filling or 10% of 50 μm hole volume height, again **5 μm thick matrix layers**.

Of course, this is a purely theoretical value, since the cooling nanoparticles can not find a solid base, but mostly only draining surfaces. It is therefore necessary to check whether the layers can be reliably applied thickly even with different temperature gradients due to varying object densities. Here the waning nano-effect could help with grain enlargement during the melting process. The lower layers could then no longer be warm enough to keep the metal melted, since the necessary melting temperature increases exponentially with the grain growth. It's like a cybernetic mechanism.

Of course, if there are no nanometallic particles of the same material available for the respective bed powder for matrix production, you can, always

- 1 . insert **plastic over the dispersion** into the powder bed as a melt matrix. One would also be possible
- 2 . go for a **polymerization of sprayed resin** in the water-based dispersion, wherein said polymerization should be initiated via the **bed powder heat** in order to save UV strips (thermal polymerization).

We will discuss these two possibilities of matrix formation in detail later.

Now you would have to try a bit: can you significantly increase the nanospheres content, e.g. bring it up to over 10%? What would be the maximum, what would be the optimal nanospheres diameter? Would slow outgassing be useful in the later sintering process? Further research must take place here.

To illustrate the layer-building, the 30% hole volume to be filled with melt, and the adjustment of the diameter of plastic balls ($d_{10\%} = 60\mu\text{m}$, $d_{90\%} = 100\mu\text{m}$) here are a few pictures:

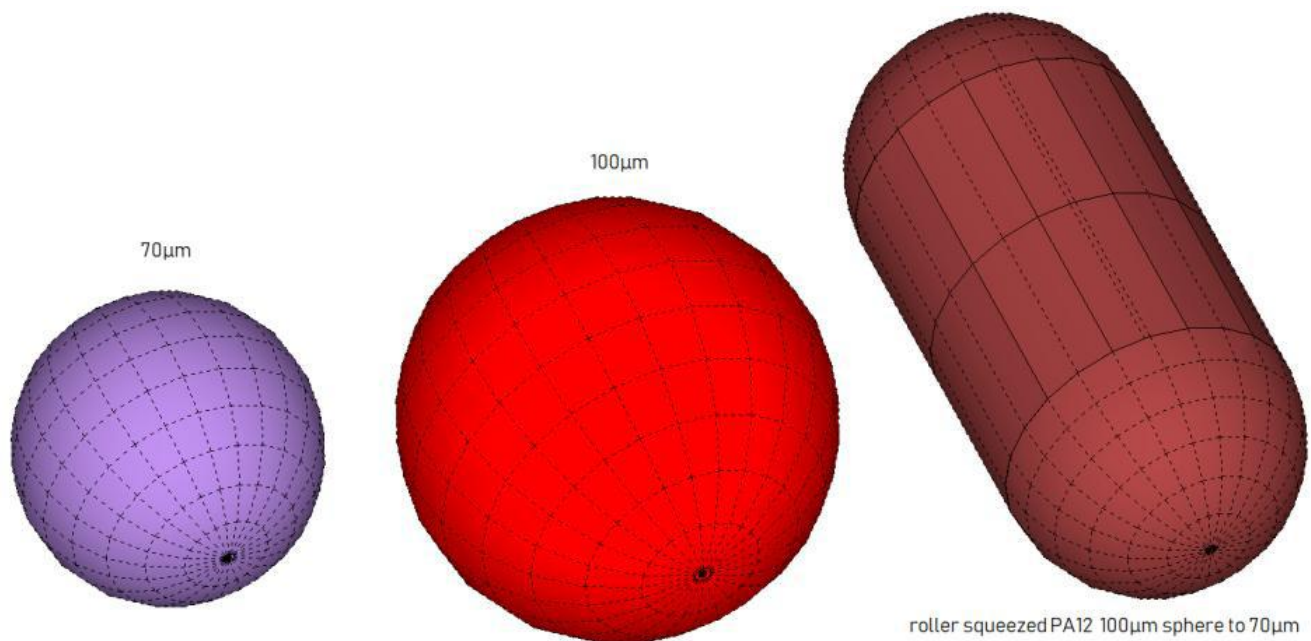

The 100 μm PA12 ball is lengthened by 88 μm when it is rolled through the slot.

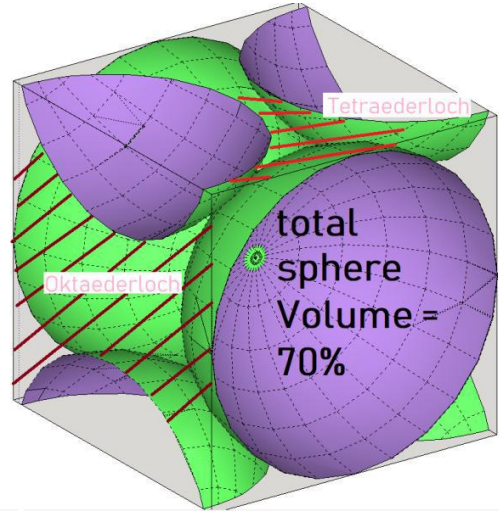
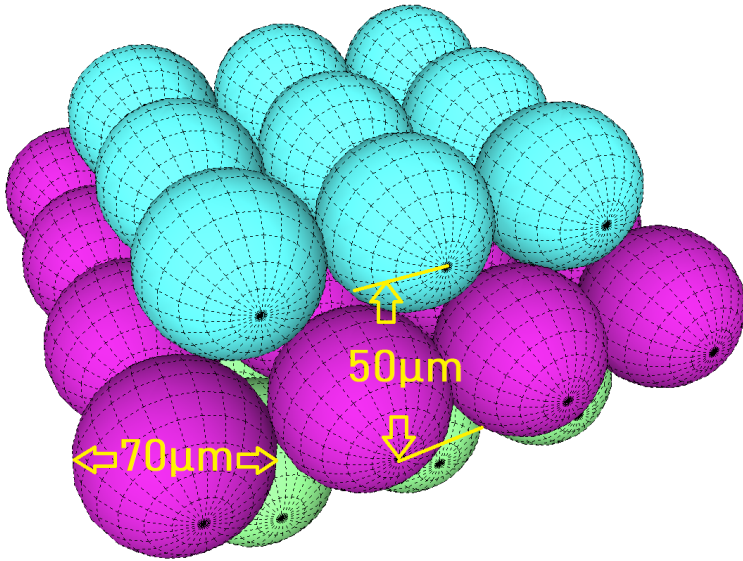

An octahedron hole is opposed to 2 tetrahedron holes, the latter making up theoretically 26% of the hole volume per hole ¼.

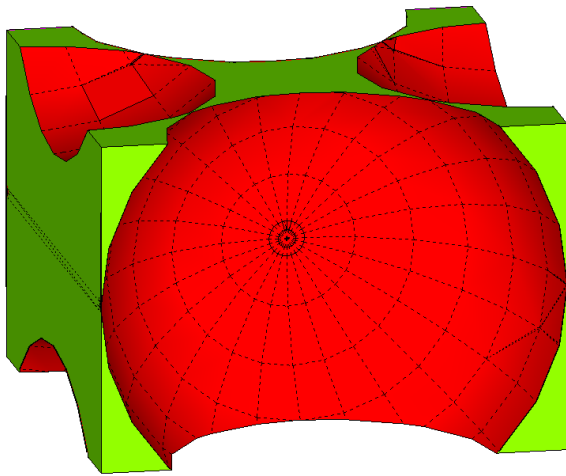

The maximum hole volume of 66pL at 50x70x70µm

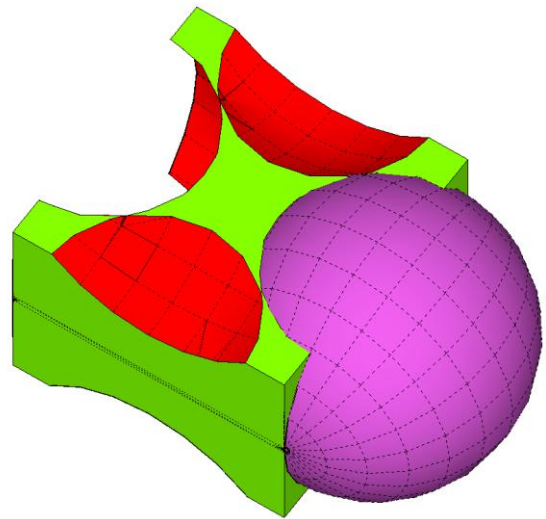

A root2 x 50µm layer height = 70.7µm ball

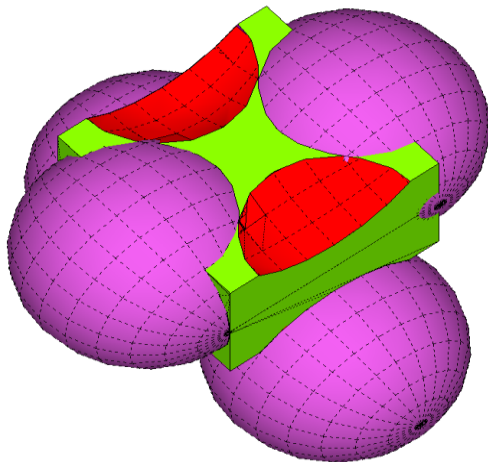

4 balls integrated in the hole volume

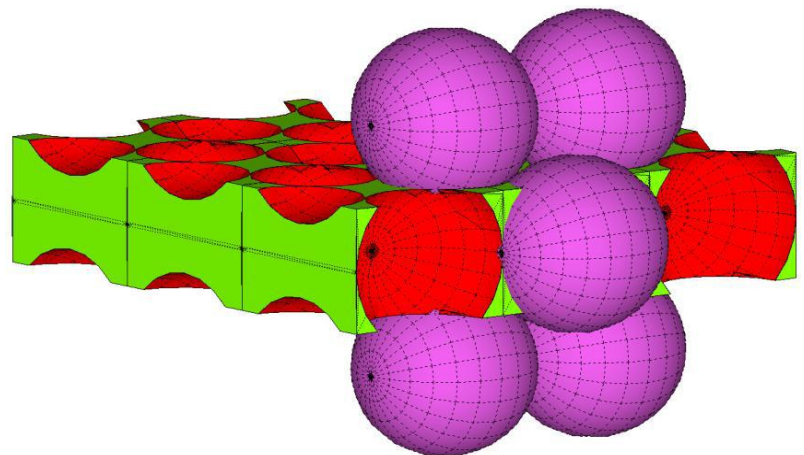

5 balls 70.7µm in the hole volume layer, each block is 50x70x70µm

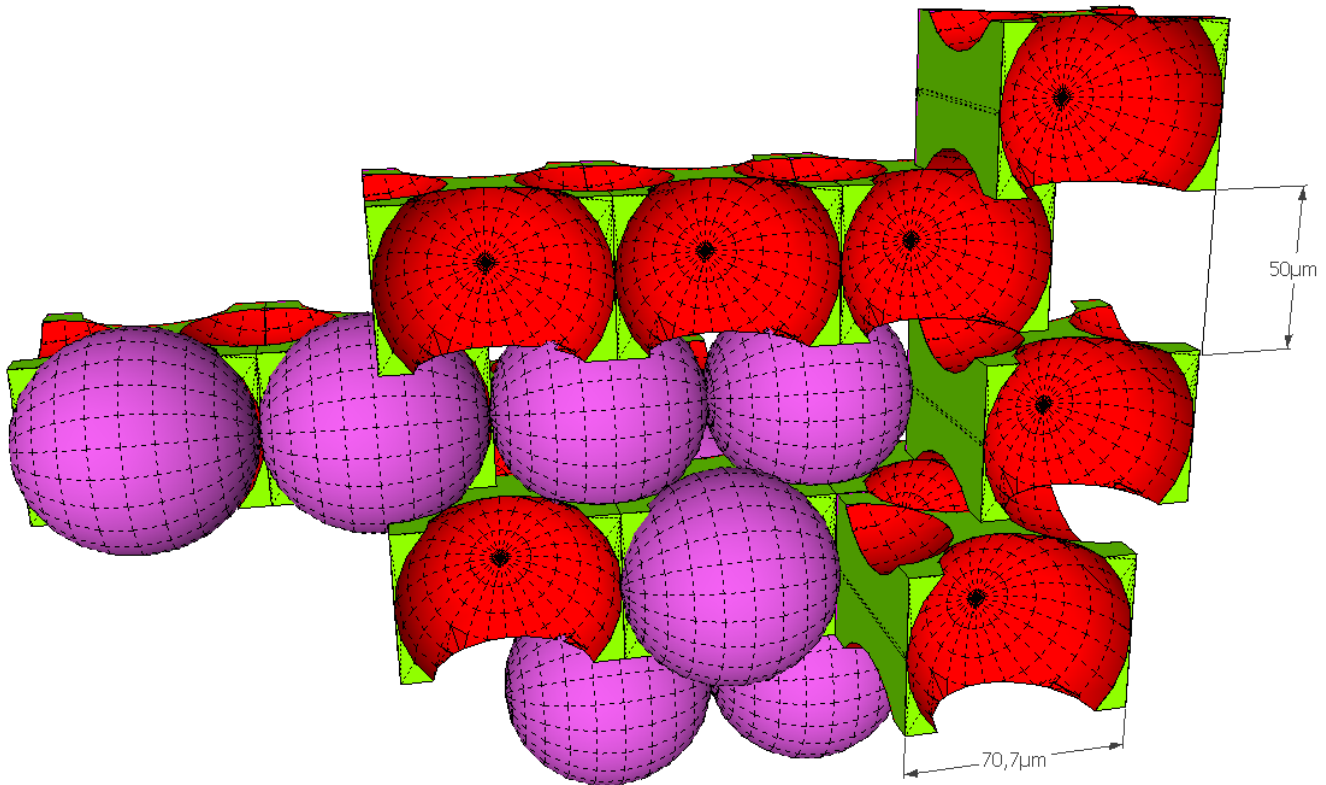

A purely theoretical representation of partially integrated $70.7\mu\text{m}$ balls in the hole matrix.

Now we want to quickly assess whether data communication via radio is problem-free: Given $20 \times 50\mu\text{m}/\text{point}$, 1 mm^2 requires 1000 binary information. The print head allows a print width of 108mm , the print length is fixed at 1000mm . This results in $108,000\text{mm}^2$ per 1000 binary signals, i.e. 108 megabits, within a layer of 100ms. The raw data transmission must therefore be around 1.1 gigabaud. A standard Internet router already does this: With 10Gb/s LAN and $4\text{-}8\text{Gb/s}$ WLAN 802.11ad for $<€ 200$, it can take over all communication. The CAD/slicing computer transfers the layer data for a maximum of 16000 layers after slicing within less than 3 minutes via a 10Gb/s LAN cable to the computer in the printer. The data capacity to be kept in the printer is approx. $1/4\text{TB}$ per print.

Matrix creation for metals and plastics: melting or gluing?

The following section discusses the processes that should connect the bed powder balls. If possible, the melting process is preferred to the gluing process (e.g. polymerization), because the latter requires de-binding and brings impurities into the product.

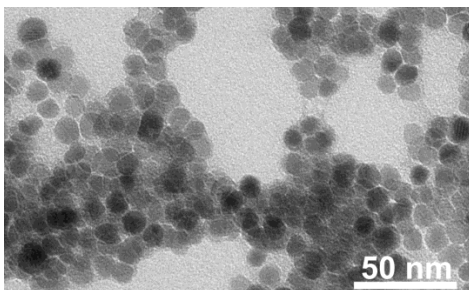

Metal printing: the metal nanoparticle melting process

The University of Braunschweig/IPAT shows fairly unimodal metal particles between 5-10nm.

The particles are produced bottom-up, using a non-aqueous synthesis.

Nanoparticles are selected so that a reduction in the melting temperature of nanoparticles occurs because the atoms on the surface of the particles experience a lower binding energy than the bulk atoms.

The smaller the particles, the greater the ratio of surface to volume. The result is that a larger part of the total number of atoms is on the surface and has a higher potential energy there, due to the surface tension. According to Julia Hambrock's dissertation, for example, about 50% of the atoms are on the surface in 50 nm particles, 50% for 2-3 nm particles and 75% of all atoms with a diameter of 1.5 nm. Surface atoms or ions with higher energy are much easier to move or even remove from the bond. The macroscopic consequence of this is a decrease in the melting temperature with a decreasing particle diameter. A melting point of approx. 500 °C has been calculated for 2 nm gold particles, which is almost 600 °C below that for a macrocrystalline composite. The Fraunhofer chart already showed silver and copper nanoparticle melting at below 200 °C, now it has to be clarified at what temperature the nano-melting effect comes into play for the respective metal.

Metal printing: jetting a water-based, thermally reactive radical starter polymer dispersion

1. the bed is not heated. This saves some effort. The balls are heated, but the Hopper Dryer can do that, as the powder tank is empty within 1.5min.
2. no ledges trailing the TIJ head, neither UV nor IR. The warm metal balls lose enough energy within the maximum 1.5min dwell time in the insulated powder tank and within 40ms between laying (on a warm bed by pre-layer) and jetting, so that evaporation is ensured. Calculations are available.
3. Jetting a water-based, thermally reactive radical starter polymer dispersion, gluing similar to how HP already does. Just without a UV bar.

The enthalpy of binding is supplied by means of thermolysis. DBPO is chosen as the radical starter and injected at RT. The reaction = cleavage temperature is, for example, 150 °C.

Tabelle 2.1. Werte der Zerfallsgeschwindigkeitskonstante k_d und der Aktivierungsenergie $E_{A,d}$ für ausgewählte thermische Initiatoren.

Initiator	Lösungsmittel	T [°C]	k_d [s ⁻¹]	$E_{A,d}$ [kJ·mol ⁻¹]
2,2'-Azo-bis-isobutyronitril (AIBN) ^[22]	Benzen	40	$4.83 \cdot 10^{-7}$	123.4
		50	$2.09 \cdot 10^{-6}$	
		60	$8.45 \cdot 10^{-6}$	
Azo-bis-isobutyramidin (AIBA) ^[23]	Wasser (pH = 1.9)	50	$8.30 \cdot 10^{-8}$	126.5
		60	$3.42 \cdot 10^{-5}$	
Di- <i>tert</i> -butylperoxid ^[24]	Benzen	80	$7.81 \cdot 10^{-8}$	142.3
		130	$2.48-3.04 \cdot 10^{-5}$	
Dibenzoylperoxid (DBPO) ^[25]	Benzen	50.8	$4.28 \cdot 10^{-7}$	123.8
		54.9	$8.53 \cdot 10^{-7}$	
		60.9	$1.66 \cdot 10^{-6}$	
Diacetylperoxid ^[26,27]	Benzen	35	$9.50 \cdot 10^{-7}$	134.0
		55	$3.14 \cdot 10^{-6}$	
		65	$1.27 \cdot 10^{-5}$	
Di- <i>tert</i> -butylhyponitrit ^[28]	Isooctan	45	$2.72 \cdot 10^{-5}$	116.9
		55	$1.07 \cdot 10^{-4}$	
		65	$4.00 \cdot 10^{-4}$	
Natriumpersulfat ^[29-30]	Wasser	40	$1.65 \cdot 10^{-2}$	83.4
		50	$4.02 \cdot 10^{-2}$	
		60	$1.08 \cdot 10^{-1}$	
	0.1 M NaOH	50	$9.50 \cdot 10^{-7}$	140.2
		60	$3.16 \cdot 10^{-6}$	
		70	$2.33 \cdot 10^{-5}$	

From the dissertation by Ingmar Polenz

Deeper discussion follows ...

Metal printing: jetting a water-based polymer dispersion

Process as above, but jetting a water-based polymer dispersion, there is no polymerization excitation, only the melting process. Experimental systems are being set up, patent specifications are being created for this idea, so a more in-depth discussion will take place later ...

Plastic printing: Jetting a water-based, thermally reactive radical starter polymer dispersion

Deeper discussion follows ...

This approach results in a

Design to be outlined ...

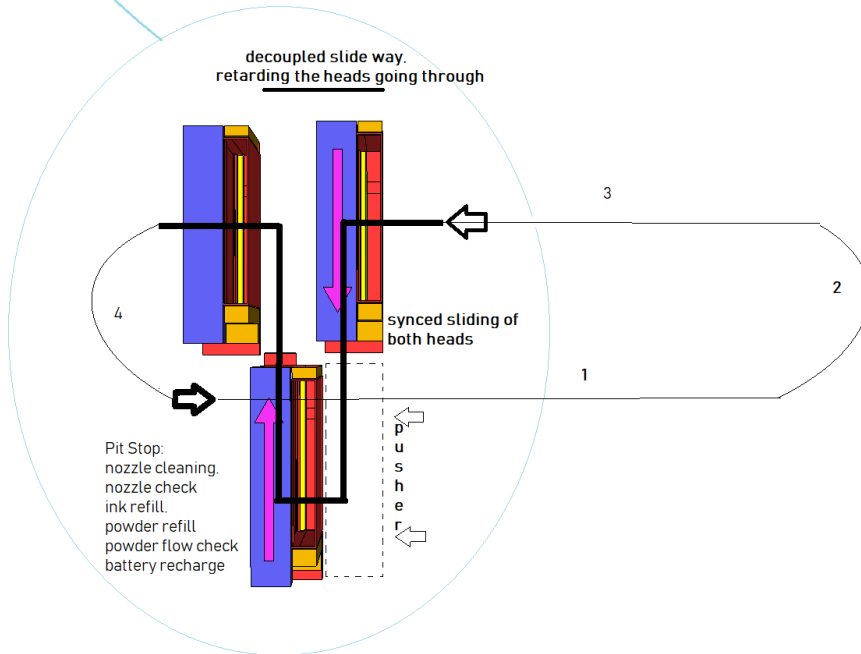
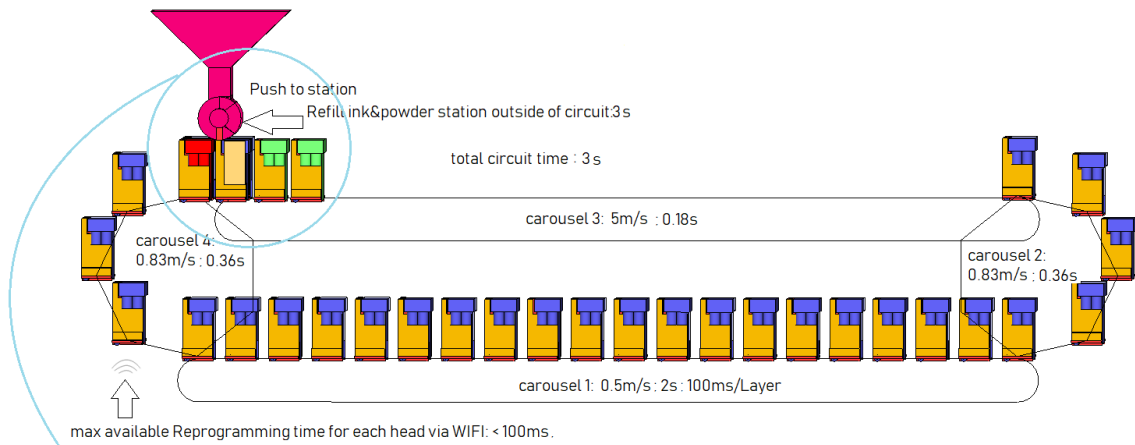

within 3 seconds: 150cm³ powder refill every 30 rounds →
within 3 seconds: 45cm³ max (optimum) ink refill every 30 rounds ↺

pit stop: 1 refill. 2 spare (green = 1 manual entry port).
space for maybe 2 repair (out of order = red = 1 manual exit port)

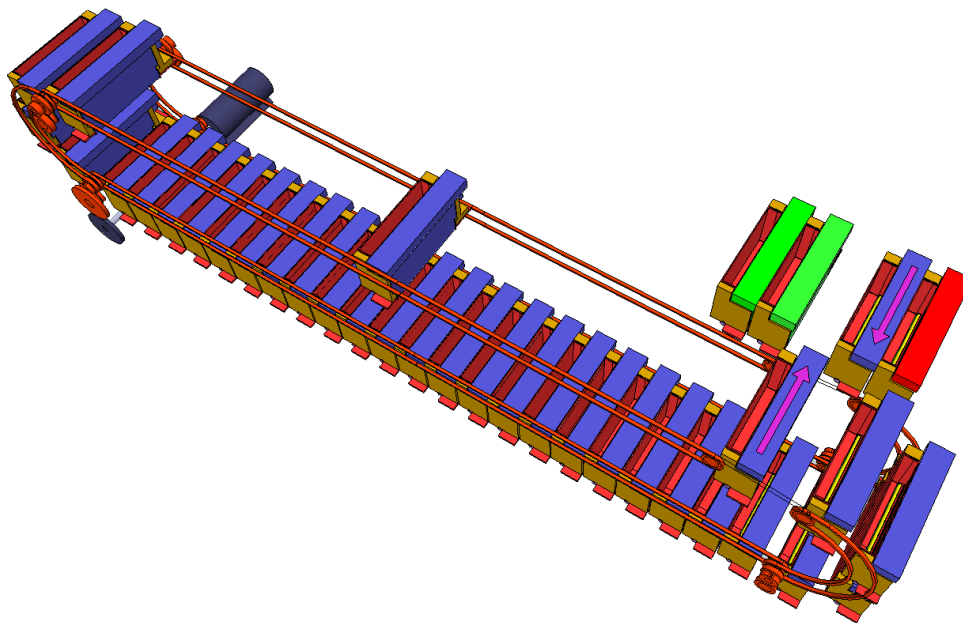
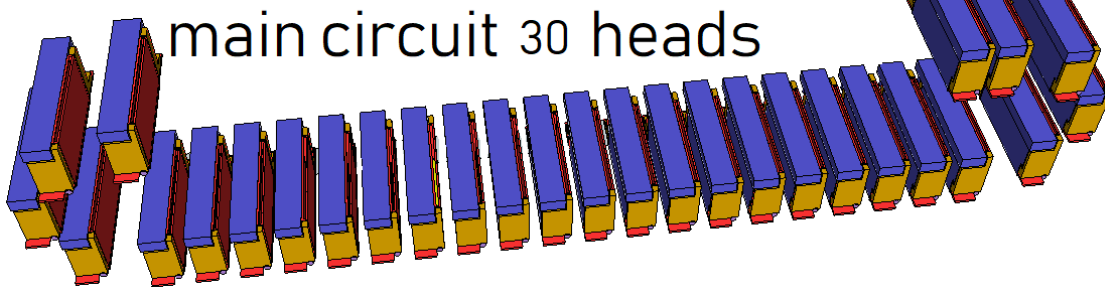

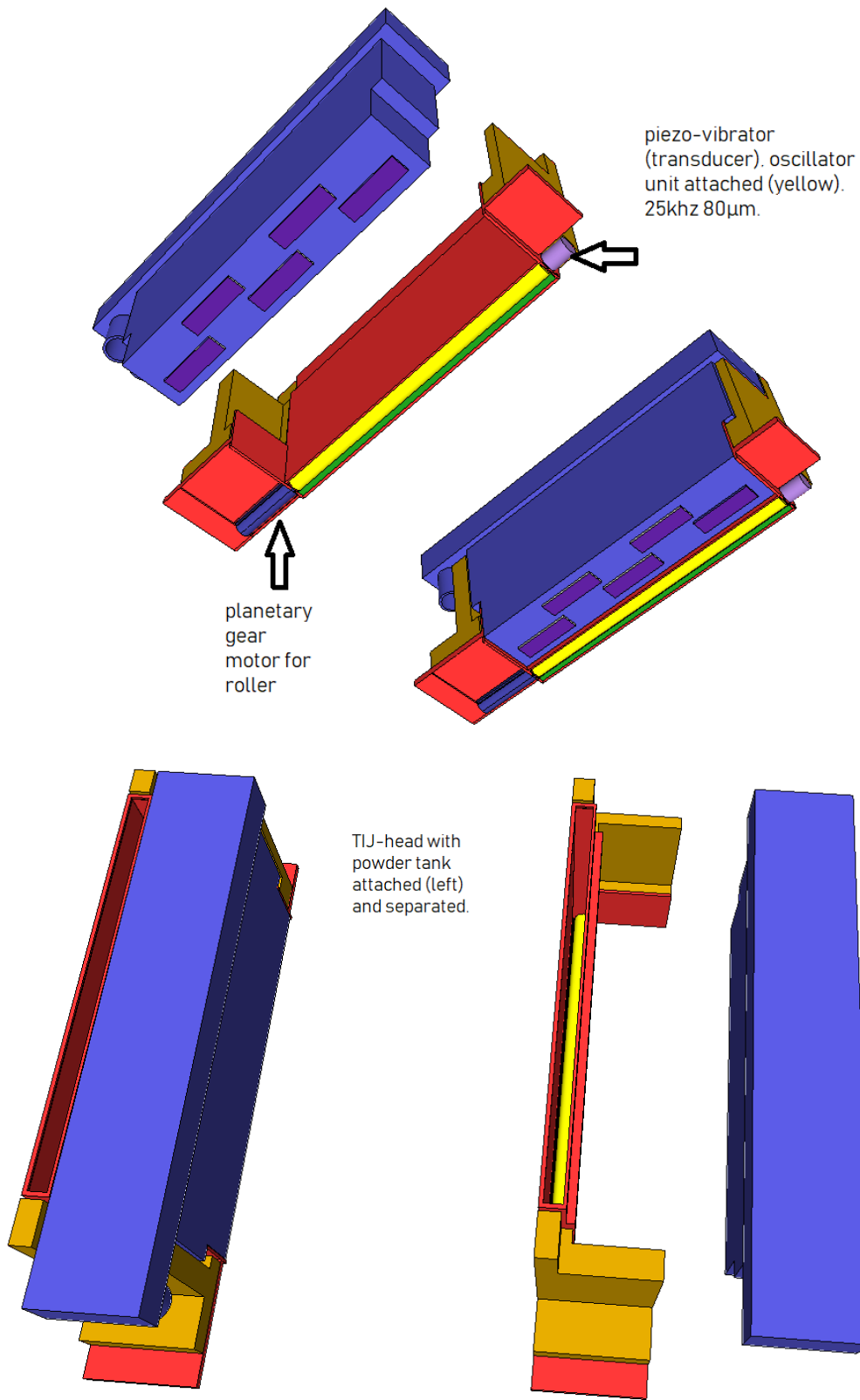

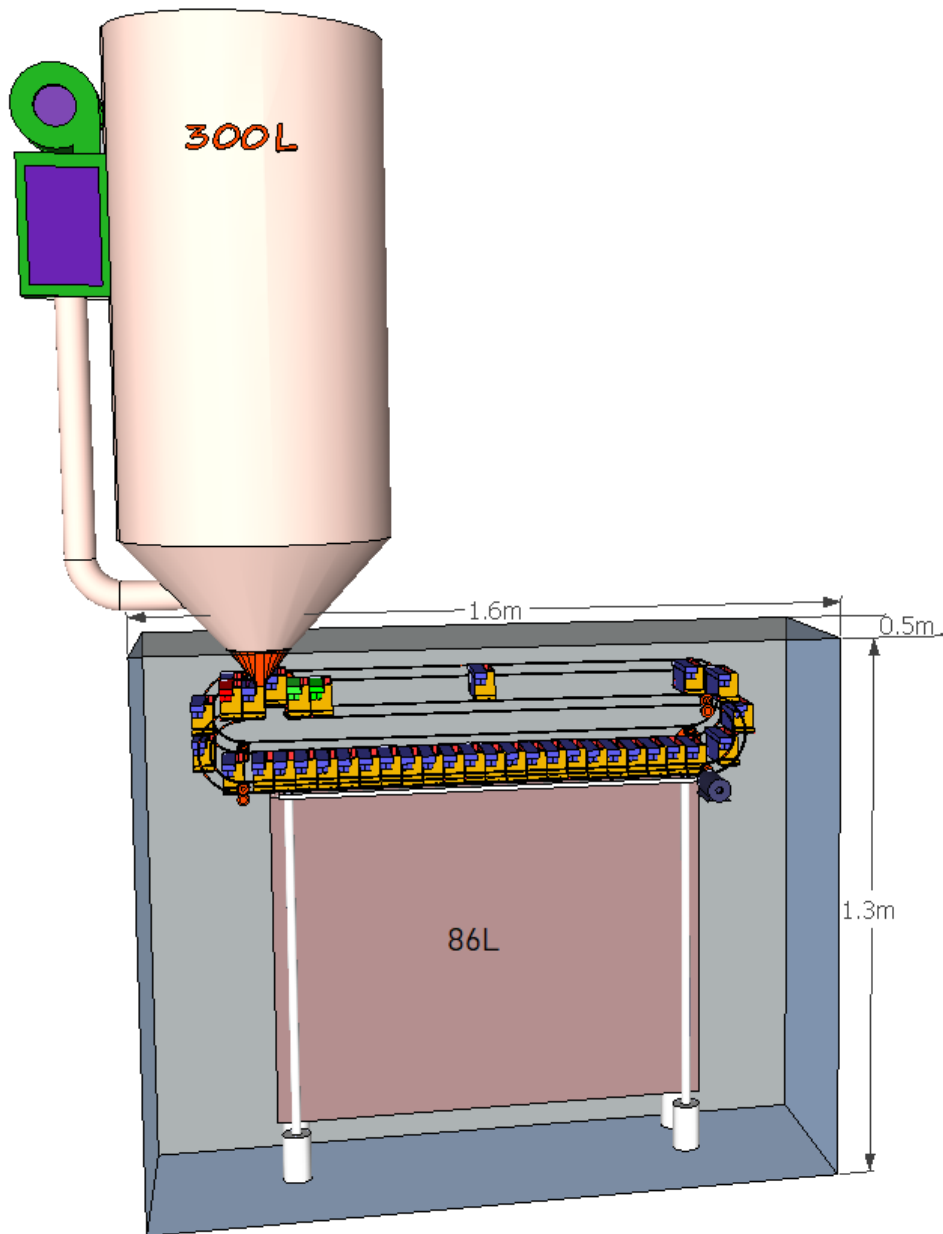

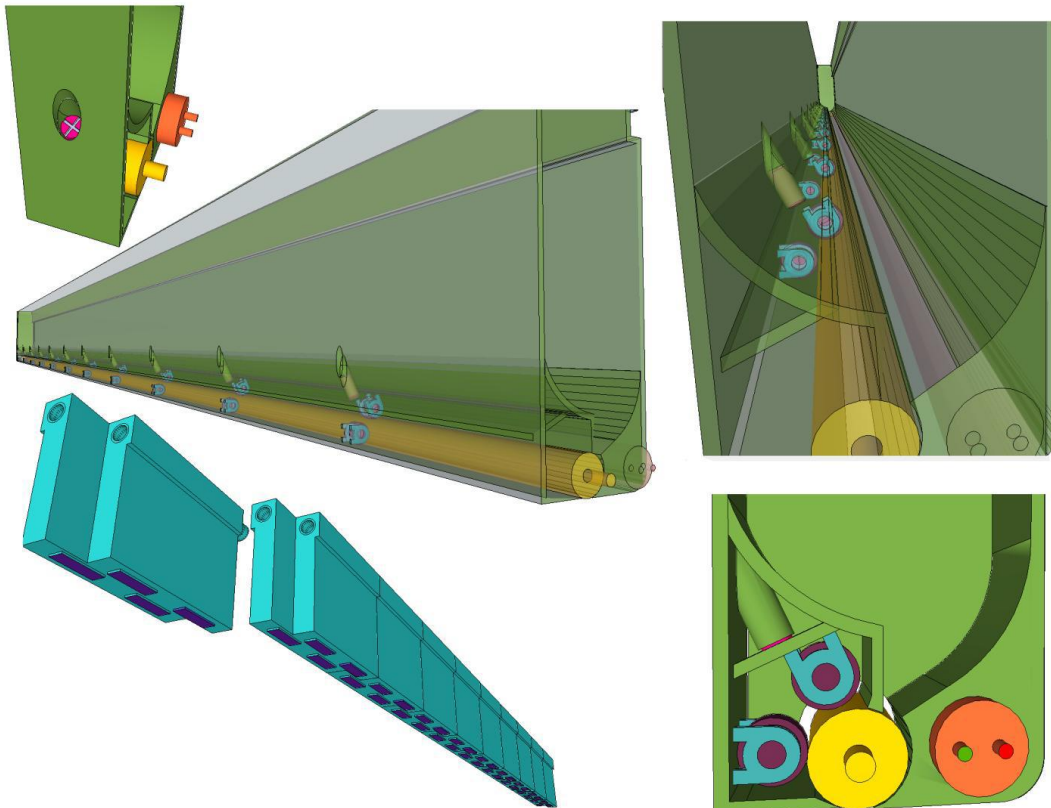
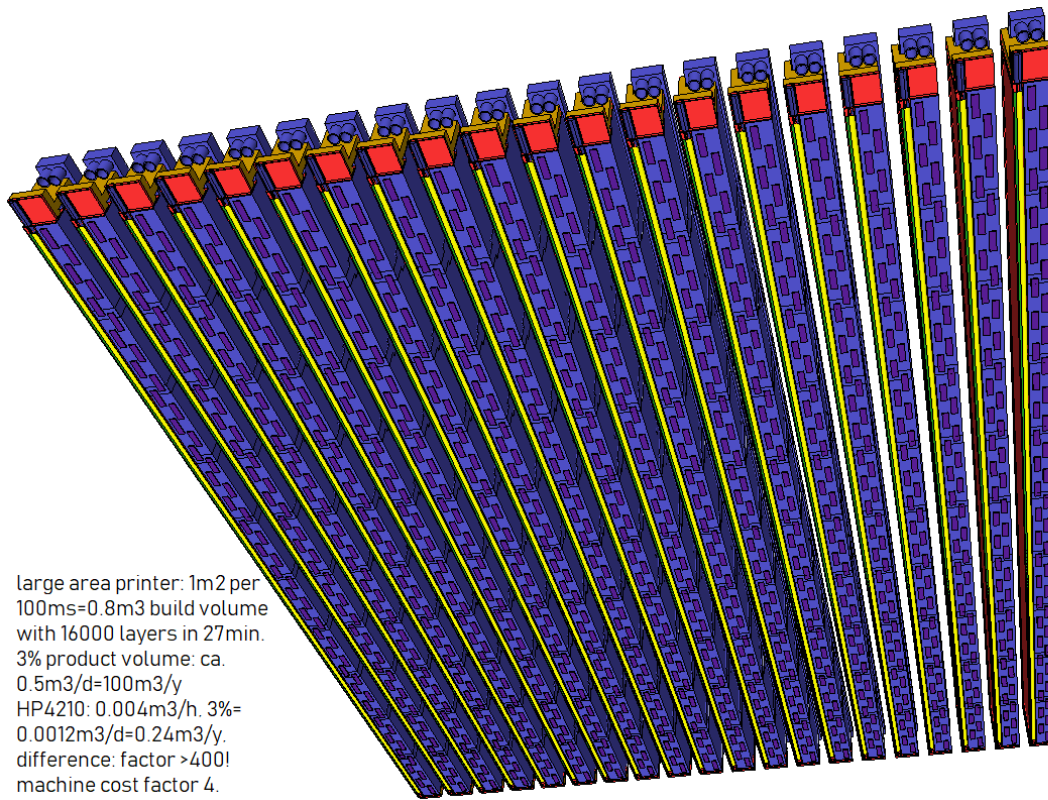

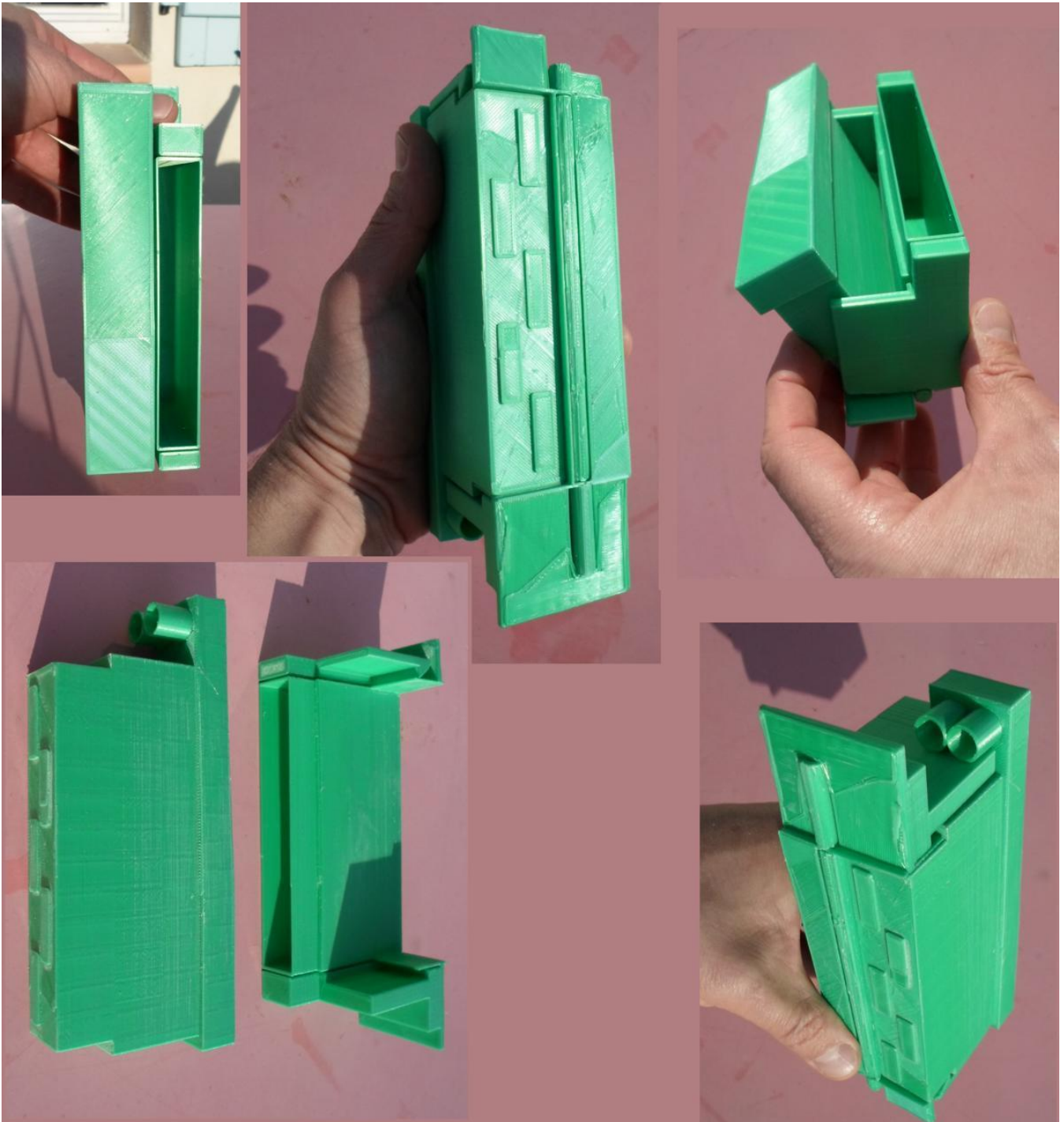

7. Outlook

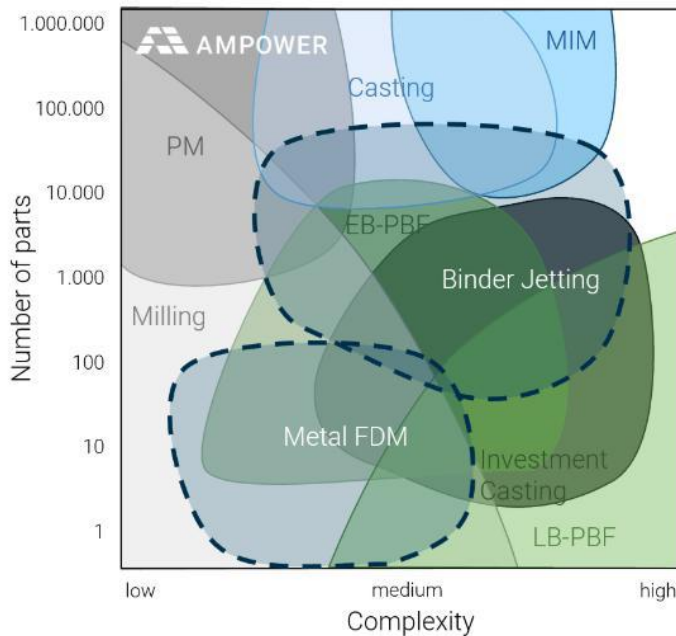

Now that we have analyzed the strengths and weaknesses of the various relevant industrial 3D printing systems, the question naturally arises: How will these systems develop? AMPower has created a clear graphic here, the statement of which I certainly share: DED is interesting for the niche market of tool restoration, and the demand will increase, but the application possibilities regarding net shape and surface quality hardly let the system slip into the mass product market. FDM is getting better and better, but cannot keep up with sintered products, I hardly see any opportunities for mass production here. EBM/SLM is as old as binder jetting, but has received much more (also scientific) attention. The system options are almost exhausted, you know what is possible, the early adopters all already have a device in their machine park. I don't see much more

space for mass production if binder jetting is now rediscovered and driven forward in terms of development technology. HP because of its size, but especially Desktop Metal because of the entry of Ford, BMW and others - with investments beyond the ¼ billion, before the introduction of the production system – beyond every normal financing dimension, tragically heaving binder jetting into the hype. If the process does not immediately deliver what was promised, the fall is deep, the 3D printing market already knows the ups and downs on the stock market as shown at the beginning of this paper, and these special developments are not desirable.

However, due to the theoretically much higher output of the Hyperfusion process compared to existing machines, I see binder jetting comparable to MIM, and contrary to the graphics, vertically superior to the MIM due to the lower unit costs for short runs.

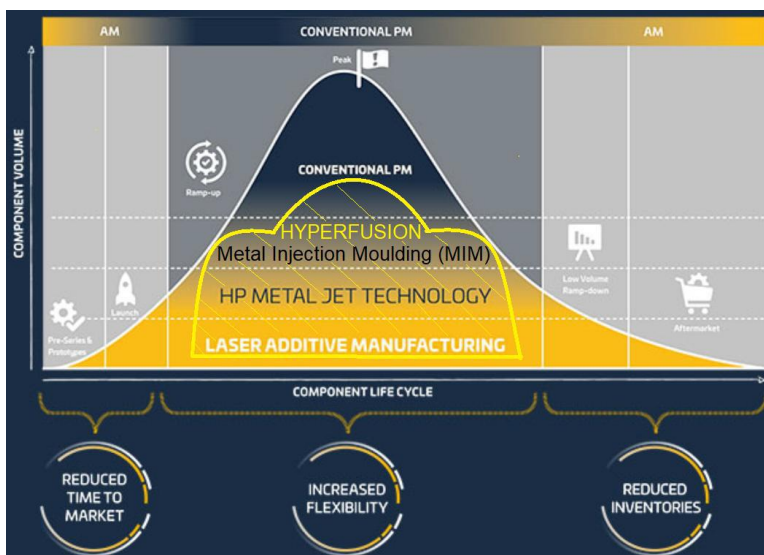

Let us now attempt to classify the Hyperfusion in terms of productivity between the other conventional/expected processes: since the device is comparable in price with SLM, EBM, HP binders and MIM machines, it can already be used for the prototype and pre-series areas. Smaller batches are just as feasible as medium-sized series, always dependent on the product size. With optimized packaging in the print bed, the planned device should, for example, create 1000 x 200cm³ parts per 200L construction volume within less than half an hour. In three-shift operation, a maximum of 2 x 1000 x 24 x 365 = 17.5 million parts per year

would be printable; 200cm³ correspond to the size of a tablet, a spectacle frame, a door handle, etc.

16 AUDI AG I/PG-T5

3D printing of Aluminum Demands of Future Cost Developments

► Visionary outlook on costs with evolutionary development in powder bed technologies

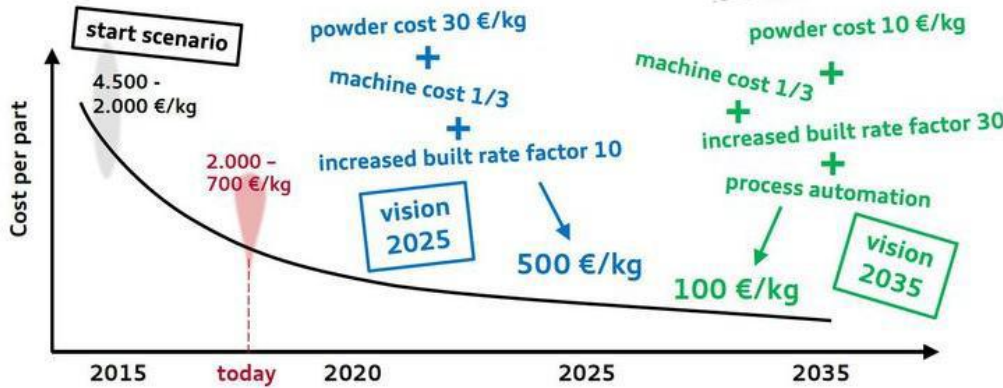

Part Volume	30 cm³	Part X	40 mm
Support Volume	0 cm³	Part Y	40 mm
Stock Material	0 cm³	Part Z (build direction)	20 mm
Material Group	Steel-base	Quantity	100000 parts

Cost per Part in €

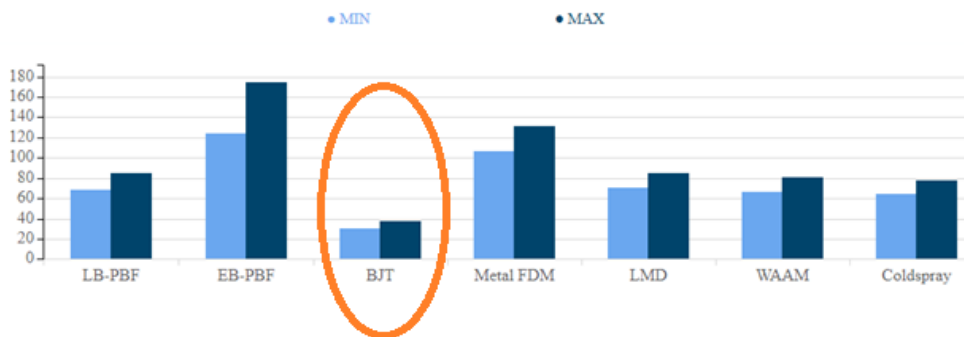

be unstoppable. The chart shows such a scenario, and the other how cheap BJT is compared to all other techs

Recurring revenues model of a 3D printer on 5 years (base 100)

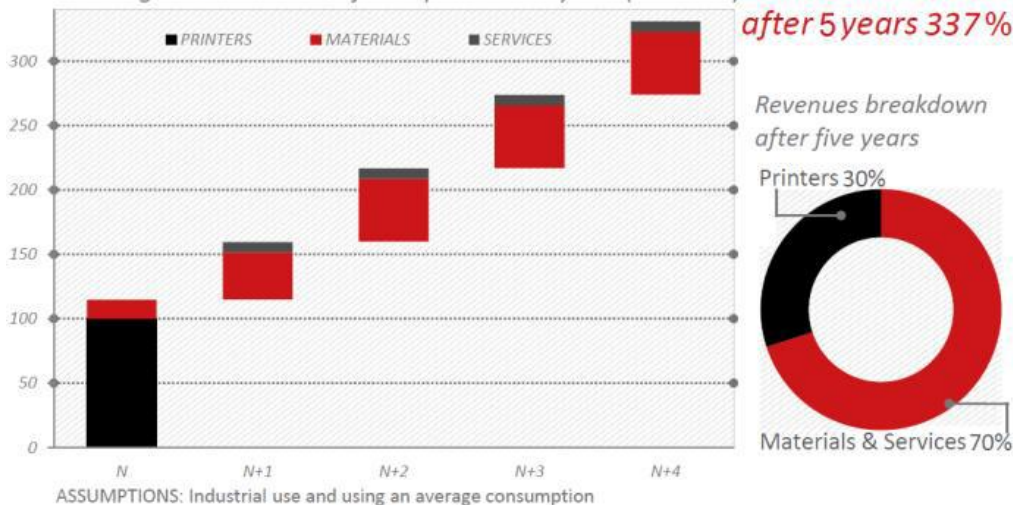

Thoughts about the sales strategy: HP pursues the same sales strategy with the Metal Jet as with the Jet Fusion: Advance notice, unsettling the market and showing beautiful product images, reducing the desire to buy elsewhere and reducing the interest in the machines of the

competitor field by having a big mouth –yet delivering their own machine might still take years. HP announces the broad sales start for the Metal Jet on its website with 2021. The strategist responsible for this declares this tactic successful for HP because the company does not lose any sales because it has no predecessors. This is how every newcomer in this segment learns how to do it ...

Give the lamp away to sell the oil, also called the "Anti Razor Blade" strategy, will be replaced by the so called "Open Platform"; I am skeptical that HP, making the complicated lamp with great effort, wants to share the oil sales with other suppliers - the actual and very profitable business with consumer goods is too important. Where there is no know-how, it certainly makes sense to learn from the professionals first, so for Jet Fusion, Evonik, BASF and other suppliers were added, and these now speak to their customers about their powder (PA12 in this case) to consume the purchase of an HP printer. Since you didn't have a product before, you don't have a customer base, which is now being built up with the customers of the suppliers. But if the market has established itself sufficiently, the Razor Blade variant will of course become more profitable again. It is already clearly shown that no liability can be assumed for the use of foreign materials and that this is much worse, since only the great own PA12 has an 80% reuse rate, so you only have to add 20% fresh powder to the next print, at Evonik that's 50%, the other providers are only just mentioned, but who wants to spend € 150,000 and then print "unsafe"?

I imagine a similar strategy for metal powders, because all available annual reports from all printer manufacturers clearly show that they are dependened on this high-margin consumer goods turnover (e.g. 3D Systems Q2/2016: product margin <33%, consumer goods margin> 75%, with a gross profit of 17 at \$31 million, consumer goods sales are also much higher)! The example chart of another company confirms the causality.

In general, it will soon become clear that the old, cumbersome, established Western democracies, which have already outsourced far too much production, will (and must) be very interested in the fact that this key technology is used for individual production in their countries, research and machine acquisition -financing is supported, intelligent jobs will be created and production will be brought back. So everything on green!

Other exciting topics such as 3D printing technologies for 24/7 resin printers on multiple tables, plastic printers spraying from the inside using robots, large daylight resin printers with an 8K monitor, gel printers with flexible nozzles for large objects (e.g. 1-100m³), etc. I explain in the business plan, please just ask.

I would like to end with a small story that I recently wrote again for a US magazine:

Refusers welcome! Why (company) success depends on outsiders, fresh flesh reds cash - and nerds top herds.

As I drove onto the parking lot I could already see the sheer dimension of this chemical producer. The barriers and welcome center only confirmed the impression: Now we are talking giants. I even hesitated to comment on the boring façade - and the orange tiles in the restroom proving the building must be of my age already - when the director led me to a glazed playground with foam benches, claiming the company has realized that a new era had arrived, and they were in midst of ramping up a special place, special team, special customer experience, special... I could see the engagement, motivation and devotion in this man, around 60, white beard, tie under a dark blue v-necked pullover. He gained all my attention when I heard this surprising phrase: "Markus, I know that I can not build up a leading team in this new, chaotic 3D printing environment, not with my staff holding highest academic credentials". For a second I thought this team builder, founding entities within evolving technologies, had understood what it takes to reinvent and bring new energy to old power. Fresh flesh reds cash! A short moment later I was disenchanted with the news that the position of strategy manager would be given to a guy who could prepare papers in a presentable way to the CTO. What? Bold bones cold coins? A few months later I gave a workshop to another big player trying to find chemistry for this post-hype 3D-printing sector, examining our many patents. Their team was led by a French marketing guy who ought to build the best team - showing no knowledge of mechanics, physics, chemistry... would he ever like the phrase: Been there, done that? When discussing bringing in hindsight from our team specialized in this field my interlocutor laughed out loud: "Could you imagine our human resource team talking to non PHDs? Haha"! Where on earth does this arrogance come from? Only PHD's got the pansophy?

Last week I visited yet another giant chemist showing the slogan: Power to do the new. I started dithering: They all want the same, and they all do the same: they try to reinvent from the inside! Power to do the new, but shouldn't the NEW bring the power? Isn't a company where it is because its people are who they are? Now how can it evolve? When a thousand horse powers weren't enough, Bugatti added another 500, changed the beast's name from Veyron to Chiron, and the price tag from one million to two. Yes, two! What do you expect from that team to come next? Won't they probably stick to their track? Comes Elon Musk, accelerates his electric roadster faster than Bugatti will ever be able to burn fuel for - and does it for a tenth of the price. Business as usual: THE REFUSERS RULE! They don't need Harvard. Huge success derives from good ideas, and nerds top herds. Take Google, Apple, Microsoft, Facebook, Tesla... there is a world of people without PHDs, some didn't even bother studying. What they have in common is that they were what I call refusers. They did the really big things without the intention. Many inventions, even honored with Nobel prizes, were "accidents". Refusers ignore the "no trespass" sign, they enter the no-go zones. Nothing ventured, nothing gained. We only hear from the winners of that strategy, yet millions lose. Now we are looking for the next Musk, or at least for the original's next thing. He forces the whole auto-world to fire the old ignition magician and hire the new accumulator demonstrator. When the paradigm shifter was asked what has been his best idea so far, he said: "Moving to the USA". Because if you need to fail in order to learn (80% do so), the best place could be progressive California. Go insolvent in conservative Europe and you are done in most cases.

This is where my experience meets my expectation: Times move fast, old companies need to turn faster than their staff is willing or capable (the same applies to nearly every civil society). Success will be determined by CEOs who prepare for the unexpected (even Jeff Bezos knows he will fail) and yet invites, welcomes and protects the "accident", integrates the hesitating refuser, copes with internal quarrels - and presents the unforeseen.

We need to broadcast these success stories of the few mighty seekers who risked a bit more than the standard golfers, and should neither flinch from collar's nor skin's color, sex, distance, certificates or whatever could hold us back from examining an idea, it might be the best one the herd will never see.

Geniusthings is a technical think-tank that has filed many patents and is currently looking for partners to realize promising 3D-printing technology-prototypes.

About the author:

Markus Ulrich is the founder and CEO of geniusthings. His think-tank offers unconventional solutions for tough nuts to crack. Markus studied mechanical engineering, founded and led an IT-database company for 13 years and built machines for all his life.